

DD  
2002  
44

**Algorithmic Methods**  
**for**  
**Three-Dimensional Topology**

2002

Yukihiro Tsutsumi

# Introduction

In this thesis, mainly we deal with compact, orientable 3-manifolds. By a *knot* we mean an embedded circle  $K$  in a 3-manifold  $M$  which is realized as a finite union of straighten segments. A disjoint union of finite number of knots is called a *link*. Several methods to represent 3-manifolds are known, triangulations, Heegaard diagrams, and surgery descriptions. A *Heegaard decomposition* of a closed 3-manifold  $M$  is a decomposition of  $M = V_1 \cup V_2$  into two handlebodies  $V_1$  and  $V_2$  such that  $V_1 \cap V_2 = \partial V_1 = \partial V_2$  and it is known that any closed 3-manifold admits a Heegaard decomposition. For a knot  $K$  in a closed 3-manifold  $M$ , by removing the interior  $\mathring{N}(K)$  of a regular neighborhood of  $K$ , and gluing a solid torus to  $\partial(M - \mathring{N}(K))$ , we obtain a new closed 3-manifold  $M'$ . This construction  $M \rightarrow M'$  is called a *Dehn surgery along  $K$* . It is known that any closed 3-manifold is obtained from the standard 3-dimensional sphere  $S^3$  by a finite number of Dehn surgery (see Lickorish [45]).

Here we consider which 3-manifolds are “generic”, in terms of decomposition along “essential submanifolds”. A 3-manifold  $M$  is called an *irreducible 3-manifold* if each embedded sphere in  $M$  bounds a 3-ball. According to Milnor [53] and Kneser [44], each closed 3-manifold  $M$  has a unique prime decomposition in the following sense: if  $M$  is expressed as a connected sum in two forms  $M = M_1 \# \cdots \# M_n = M'_1 \# \cdots \# M'_m$ , then it follows that  $m = n$  and after reordering suitably,  $M_i$  is homeomorphic to  $M'_i$ . Thus in concerning general 3-manifolds, it is natural to begin with irreducible 3-manifolds.

A surface  $S$  properly embedded in  $M$  or contained in  $\partial M$  is said to be *incompressible* in  $M$  if  $S$  is not simply connected and for any embedded disk  $D$  in  $M$  such that  $D \cap S = \partial D$ , it follows that  $\partial D$  bounds a disk in  $S$ . A 3-manifold  $M$  is said to be  *$\partial$ -irreducible* if  $\partial M$  is incompressible in  $M$ . Jaco and Shalen [30], and Johannson [33] showed independently that any irreducible 3-manifold  $M$  has the unique torus decomposition, so called *JSJ-decomposition*, that is, if an irreducible 3-manifold  $M$  contains essential tori, then it admits the unique disjoint union of essential tori  $\mathcal{T}$ , up to isotopy, such that each component of  $M - \mathring{N}(\mathcal{T})$  is a Seifert fibered space or a simple 3-manifold. In [70], Thurston introduced hyperbolic structures to 3-manifolds and showed that an atoroidal and anannular Haken manifold, that is, an irreducible and  $\partial$ -irreducible 3-manifold which contains incompressible surface but does not contain essential tori nor annuli, admits a complete hyperbolic structure of finite volume. By the Mostow rigidity, the volume turns out to be a topological invariant. By these

results, our interests is naturally directed to simple 3-manifolds and Seifert fibered spaces, in terms of decomposing 3-manifolds into “generic 3-manifolds” along essential surfaces.

Definitions and notation described in Introduction will be restated in each chapter precisely. This article is organized as follows.

In Chapter 1, we give a summary on incompressible surfaces in Haken 3-manifolds, and describe basic lemmas needed later to construct knots and 3-manifolds by cut-and-pasting arguments, those are based on the author’s Master Thesis [80].

In Chapter 2, we describe a phenomenon on genus one hyperbolic knots that depends only on the existence of closed essential surfaces in the ambient manifolds. A knot  $K$  in  $M$  is said to be *hyperbolic* if the complement  $M - K$  admits a complete hyperbolic structure of finite volume. By Thurston’s hyperbolization result ([70],[54]) it is equivalent to  $E(K) = M - \mathring{N}(K)$  is simple. Any knot  $K$  in a homology sphere  $M$  bounds a Seifert surface, that is, a connected, orientable surface  $S$  embedded in  $M$  such that  $S \cap K = \partial S = K$ . The least genus of Seifert surfaces for  $K$  is called the *genus of  $K$*  and denoted by  $g(K)$ . By the very definition, if  $S$  is a minimal genus Seifert surface for  $K$ , then  $S$  is incompressible. One can construct a genus one knot  $K$  which bounds a huge number of mutually disjoint, non-parallel genus one Seifert surfaces, but  $K$  turns out to contain essential tori in  $E(K)$ . The essential problem is, how one can construct hyperbolic knot which bounds a large number of mutually disjoint genus one Seifert surfaces. Our main result in Chapter 2 is that any hyperbolic knot in a non-Haken manifold bounds at most seven mutually disjoint, genus one Seifert surfaces. This result can be applied to a study of toroidal surgeries on hyperbolic knots. Some examples of hyperbolic knots which admit toroidal surgeries that produce 3-manifolds with non-trivial JSJT-decompositions.

In Chapter 3, we discuss Seifert surfaces for knots which contain accidental peripherals. For a properly embedded surface  $S$  in a 3-manifold  $M$  with toroidal boundary, a closed curve  $l$  in  $S$  is called an *accidental peripheral* if  $l$  is freely homotopic to  $\partial M$  but it is an essential curve in  $S$ . Such a property is important in hyperbolic geometry. S. Fenley [7] observed that any minimal genus Seifert surface for a knot in  $S^3$  does not contain accidental peripherals, using a result of Gabai [11] on good Reebless foliations of the knot complements in  $S^3$ . Then it turns out to be unknown that if there is a knot which bounds an incompressible Seifert surface with accidental peripherals. We could answer this problem affirmatively. We give several properties of incompressible Seifert surfaces with accidental peripherals, and a method to construct knots which admit such Seifert surfaces. This work is partially based on joint works ([25], [60]) with Makoto Ozawa.

Chapter 4 is devoted to results of some computer experiment. SnapPea (cf. [84]) is a family of computer programs developed by J. Weeks, by which one can calculate several hyperbolic invariants, volumes, isometry groups, ..., from ideal triangulations of cusped hyperbolic 3-manifolds. It contains a routine that gives an ideal triangulation of a knot complement from a Gauss chord diagram. Several interfaces to SnapPea are developed by

many people and available on the Web. The author also made a visual tool which has an interface to SnapPea, calculate the Casson-knot invariant, and can output the knot-link diagram in EPS format, in order to improve the rate of study. Most pictures of knots and links with polygonal segments (Figure 3.1 for example) in this article are drawn with the author's tool. Several examples hyperbolic 3-manifolds small volumes in some classes are demonstrated and a method to recognize a triangulation of a 3-manifold from a Heegaard decomposition is considered.

In contrast to Chapter 4, we consider in Chapter 5 how to prove a given 3-manifold is hyperbolic. In 1960's early, W. Haken [16] constructed an algorithm to detect if a compact irreducible 3-manifold with boundary is  $\partial$ -irreducible or not. This algorithm is known as *Haken's algorithm*. Though it is effective and assured to stop after finite steps, but is not adaptable for an execution by hand. There we give a sufficient condition for a certain 3-manifold to have incompressible boundary. The class of 3-manifold dealt with consists of the exteriors of spatial graphs in  $S^3$ . By a *spatial graph*, we mean an embedded graph in  $S^3$ . This application to spatial graphs is based on a joint work with Makoto Ozawa [61].

In Chapter 6, we study some homological invariant of knots and homology spheres. Especially, the following basic problems are concerned: (1) when two knots produce the same surgery manifold, what happens to their Alexander-Conway polynomials and (2) how to construct distinct knots with the same surgery manifold. To distinguish knots with the same algebraic invariants, we can adapt a result on incompressible surfaces. It is remarked that our construction is mainly based on knotting Seifert surfaces. Thus our interest is naturally directed to invariants which are derived from Seifert surfaces. The Alexander-Conway polynomial is an example of such polynomial invariants. In the chapter, we study the behavior of Conway polynomial under "homological twists" on knots. Main part of this chapter is based on a joint work with Harumi Yamada.

## Acknowledgments

I am grateful to Ipeei Ishii for his constant encouragements. I would like to express my gratitude to Tsuyoshi Kobayashi, Kimihiko Motegi, and Masakazu Teragaito for their helpful comments and discussions. Several topics related to some part of my work were discussed in a mailing list organized by Makoto Ozawa.



# Contents

<b>1</b>	<b>Essential surfaces in Haken manifolds</b>	<b>6</b>
1.1	Summary on essential surfaces . . . . .	6
1.2	Gluing lemmas . . . . .	7
<b>2</b>	<b>Universal finiteness results on genus one hyperbolic knots</b>	<b>11</b>
2.1	Preliminaries . . . . .	11
2.1.1	Definitions . . . . .	11
2.1.2	Lyon’s argument . . . . .	12
2.2	Universal bounds for genus one knots . . . . .	13
2.3	Constructions . . . . .	16
2.3.1	Non-trivial JSJT-decompositions . . . . .	16
2.3.2	Higher genus Seifert surfaces . . . . .	18
2.4	More on Proposition 2.3.1 . . . . .	21
2.4.1	Examples of double-torus knots . . . . .	23
<b>3</b>	<b>Accidental essential surfaces and excellent Seifert surfaces</b>	<b>26</b>
3.1	Review of accidental surfaces . . . . .	26
3.1.1	Definitions . . . . .	26
3.1.2	Accidental closed surfaces . . . . .	26
3.1.3	Accidental surfaces with boundary . . . . .	27
3.1.4	Accidental Seifert surfaces . . . . .	28
3.2	Properties of accidental Seifert surfaces . . . . .	29
3.2.1	Boundary slopes of essential accidental surfaces . . . . .	31
3.2.2	On general 3-manifolds . . . . .	34
3.3	Satellite knots with accidental Seifert surfaces . . . . .	35
3.3.1	Construction . . . . .	35
3.4	Hyperbolic knots with accidental Seifert surfaces . . . . .	37
3.4.1	Preliminaries . . . . .	39
3.4.2	Proof of Theorem 3.4.1 . . . . .	39

3.5	Excellent Seifert surfaces and applications to accidental surfaces . . . . .	44
3.5.1	Excellent Seifert surfaces . . . . .	46
3.5.2	Construction . . . . .	47
3.5.3	Accidental surfaces . . . . .	51
<b>4</b>	<b>Experiments</b>	<b>52</b>
4.1	Digging against hyperbolic 3-manifolds of small volumes in several situations	52
<b>5</b>	<b>Applications of the Handle Addition Lemma</b>	<b>56</b>
5.1	A sufficient condition for spatial graphs to be totally knotted . . . . .	56
5.1.1	A sufficient condition . . . . .	57
5.1.2	Spatial graphs . . . . .	61
5.2	Handle additions that produce products . . . . .	64
5.2.1	Gluing lemma . . . . .	65
5.2.2	Sweeping out lemma . . . . .	67
5.2.3	Proof of Theorem 5.2.1 . . . . .	68
<b>6</b>	<b>Surgery descriptions of homology spheres</b>	<b>70</b>
6.0.4	Preliminaries . . . . .	72
6.0.5	Semi standard forms of Seifert matrices and realizing Conway polynomials . . . . .	75
6.0.6	Proof of Theorem 6.0.9 and its application . . . . .	78
6.0.7	More on Theorem 6.0.9 . . . . .	81

# Chapter 1

## Essential surfaces in Haken manifolds

### 1.1 Summary on essential surfaces

In this section, we summarize results on essential surfaces in 3-manifolds without proofs. Without stated otherwise, all 3-manifolds are assumed to be compact and orientable, and surfaces are orientable. Let  $S$  be a properly embedded surface in  $M$  or a submanifold in  $\partial M$ . A *compression disk*  $D$  of  $S$  is an embedded disk in  $M$  such that  $D \cap S = \partial D$  and  $\partial D$  does not bound a disk in  $S$ . We say a non-simply connected  $S$  embedded in  $M$  is said to be *incompressible* if  $S$  has no compression disk. A  *$\partial$ -compression disk* of  $S$  is an embedded disk  $D$  in  $M$  such that  $\partial D = \alpha \cup \beta$  where  $\alpha, \beta$  are connected arcs with  $D \cap S = \alpha$  and  $D \cap \partial M = \beta$ , and that  $\alpha$  is an essential arc in  $S$ . A properly embedded surface is said to be  *$\partial$ -incompressible* if it admits no  $\partial$ -compression disk. A surface properly embedded in  $M$  is *essential* if it is incompressible and not parallel to  $\partial M$ .

A 3-manifold  $M$  is said to be *irreducible* if  $M$  has no sphere  $E$  which does not bound a 3-ball in  $M$ , otherwise,  $M$  is *reducible*. We say a 3-manifold  $M$  with non-empty boundary is  *$\partial$ -irreducible* if  $\partial M$  is incompressible in  $M$ . A 3-manifold without essential tori (annuli resp.) is called an *atoroidal* (*anannular* resp.), and a 3-manifold which is irreducible,  $\partial$ -irreducible, atoroidal and anannular is said to be *simple*. *Haken manifold* means a 3-manifold which is irreducible and contains incompressible surfaces.

The following is known as Haken finiteness.

**Theorem 1.1.1** (cf. [16]). *Let  $M$  be an irreducible,  $\partial$ -irreducible 3-manifold. There exists an integer  $h(M)$  such that if  $S_1, \dots, S_n$  are mutually disjoint, non-parallel, incompressible,  $\partial$ -incompressible surfaces in  $M$ , then  $n < h(M)$ .  $\square$*

By performing 0-surgery along a two-bridge knot with a “long continued fraction expan-

sion”, we obtain a Haken manifold of Heegaard genus two with large Haken number.

It is not so hard to construct a simple Haken 3-manifold which admits infinitely many incompressible surfaces, up to isotopy. A method to construct such a 3-manifold is given in Chapter 3. In fact, if  $M$  is a surface bundle over  $S^1$  such that  $\beta_2(M) > 1$ , then  $M$  admits infinitely many fibrations over  $S^1$ , up to isotopy [58].

We say a closed incompressible surface  $S$  embedded in a 3-manifold  $M$  is *acylindrical* if the cutting result  $M - \mathring{N}(S)$  does not contain essential annuli. Under this condition, we get a finiteness result stronger than Theorem 1.1.1. We know the following.

**Theorem 1.1.2** ([17], [72], [73]). *Let  $M$  be a Haken 3-manifold. There are only finitely many acylindrical surfaces in  $M$ , up to isotopy.*  $\square$

Furthermore, there is an algorithm to search all acylindrical surfaces in a Haken 3-manifold from a given triangulation of  $M$  [72].

We described two types of incompressible surfaces, fibers of fibrations over  $S^1$  and acylindrical surfaces. For simple Haken 3-manifolds, we can associate a non-negative integer  $k$  and  $\infty$  to each incompressible surface  $S$  in a suitable way as follows:  $\ell(S) = \infty$  if and only if  $S$  is a fiber of a fibration over  $S^1$ , and  $S$  is acylindrical if and only if  $\ell(S) = 0$  ([12],[79]).

As an example of applications of acylindrical surfaces, we observe the following.

**Lemma 1.1.3** ([78]). *Let  $M$  be a simple 3-manifold with non-empty boundary. Let  $F_1$  and  $F_2$  be homeomorphic components of  $\partial M$ , and  $f : F_1 \rightarrow F_2$  homeomorphism. For any self-homeomorphism  $h : F_1 \rightarrow F_2$  of infinite order,  $\{M_i = M/(f \circ h^i)\}$  contains infinitely many homeomorphs.*  $\square$

## 1.2 Gluing lemmas

We show the following “gluing lemmas” needed later.

**Lemma 1.2.1.** *Let  $M$  be an irreducible,  $\partial$ -irreducible 3-manifold, and let  $F_1$  and  $F_2$  be homeomorphic surfaces in  $\partial M$  such that  $\partial M - (\partial F_1 \cup \partial F_2)$  is incompressible in  $M$ . Then the manifold  $M'$  obtained by gluing  $F_1$  to  $F_2$  is irreducible and  $\partial$ -irreducible.*

*Proof.* Let  $F$  be the surface properly embedded in  $M'$  obtained by gluing  $F_1$  and  $F_2$ . We consider  $M$  as the cutting result  $M - \mathring{N}(F)$ . It is easy to see that  $F$  is incompressible and  $\partial$ -incompressible in  $M'$ , by the incompressibility of  $\partial M$  and  $\partial M - (\partial F_1 \cup \partial F_2)$ .

Let  $E$  be a reducing sphere in  $M'$ . If  $E \cap F = \emptyset$ , then  $E$  is contained in  $M$ . Since  $M$  is irreducible,  $E$  bounds a 3-ball in  $M$ . Thus,  $E$  also bounds a 3-ball in  $M$  and in this case  $E$  is not a reducing sphere in  $M'$ . Hence we assume that  $E \cap F \neq \emptyset$  and  $|E \cap F|$  is minimal among all reducing spheres of  $M'$ . Let  $E'$  be an innermost disk in  $E$  with respect to  $E \cap F$ . Since  $F$  is incompressible,  $\partial E'$  bounds a disk  $E''$  in  $F$ . By the irreducibility of

$M$ , the sphere  $E' \cup E''$  bounds a 3-ball on the side not containing  $F$  and  $\partial M'$ , thus  $E$  is isotopic to a sphere  $E^*$  with  $|E \cap F| > |E^* \cap F|$ . This contradicts the minimality of  $|E \cap F|$ .

Let  $D$  be a  $\partial$ -reducing disk of  $M'$ . If  $D \cap F = \emptyset$ , then we can show that  $D$  is a compression disk of  $\partial M - (\partial F_1 \cup \partial F_2)$  and this is a contradiction. Thus we suppose  $D \cap F \neq \emptyset$  and assume  $|D \cap F|$  is minimal among all  $\partial$ -reducing disks. By an innermost argument, we may assume  $D \cap F$  consists of arcs. Let  $\alpha$  be an outermost arc and  $D'$  be the corresponding outermost disk of  $D$  with respect to  $D \cap F$ . Since  $F$  is  $\partial$ -incompressible, there is a disk  $D''$  in  $F$  such that  $D'' \cap D' = \alpha$ . Since  $\partial M - (\partial F_1 \cup \partial F_2)$  is incompressible in  $M$ , for the disk  $D_1 = D'' \cup D'$ ,  $\partial D_1$  bounds a disk  $D_2$  in  $\partial M'$ . By the irreducibility of  $M$ , the sphere  $D_1 \cup D_2$  bounds a 3-ball and  $D$  is isotopic to a disk  $D^*$  with  $|D \cap F| > |D^* \cap F|$ , and this is a contradiction to the minimality of  $|D \cap F|$ . Such an argument is called an “outermost argument”.  $\square$

**Lemma 1.2.2.** *Let  $M$  be an irreducible,  $\partial$ -irreducible, and atoroidal 3-manifold and  $F_1$  and  $F_2$  be homeomorphic surfaces in  $\partial M$  without toral components and annular components such that  $\partial M - (\partial F_1 \cup \partial F_2)$  is incompressible in  $M$ . If there is no essential annulus  $A$  in  $M$  such that a component of  $\partial A$  is contained in  $F_1$  and there is no essential annulus such that whose boundary is contained in  $\partial M - (F_1 \cup F_2)$ , then the manifold  $M'$  obtained by gluing  $F_1$  to  $F_2$  is simple.*

*Proof.* Let  $F$  be the surface properly embedded in  $M'$  obtained by gluing  $F_1$  and  $F_2$ . We consider  $M$  as the cutting result  $M - \mathring{N}(F)$  and it is easy to see that  $F$  is incompressible and  $\partial$ -incompressible.

By Lemma 1.2.1,  $M'$  is irreducible and  $\partial$ -irreducible. Let  $T$  be an essential torus in  $M'$ . Since  $M$  is atoroidal and  $F$  has no annular or toral component,  $T$  intersects  $F$  so that each component  $T'$  of  $T - \mathring{N}(F)$  forms an essential annulus in  $M$  or an annulus parallel to an annulus  $A'$  in  $\partial M$ . In the latter case,  $A'$  is a union of three annuli, two of them are some caller neighborhoods  $C_1$  and  $C_2$  of  $\partial F_i$  and the other is the closure  $C_3$  of an annular component of  $\partial M - (F_1 \cup F_2)$ . By pushing  $T'$  to  $C_3$ , we obtain an essential annulus  $A$  properly embedded in  $M'$ . It is easy to see that  $A$  is incompressible since  $T$  is incompressible. If  $A$  is  $\partial$ -parallel, then  $T$  is  $\partial$ -parallel, or  $T$  bounds a solid torus. Thus,  $A$  is essential in  $M'$  and we will deal with essential annuli later. Hence we may assume  $T'$  is an essential annulus in  $M$ . However this contradicts the condition that there is no essential annulus with some boundary component contained in  $F_1$ .

Let  $A$  be an essential annulus in  $M'$ . By the same argument as above, we may assume that  $A \cap F$  consists of essential arcs of  $A$  and  $|A \cap F|$  is minimal among such essential annuli. Let  $D$  be a component of  $A - \mathring{N}(F)$ . Since  $M$  is  $\partial$ -irreducible,  $\partial D$  bounds a disk  $D'$  in  $\partial M$ . By the incompressibility of  $F$  in  $M'$ ,  $D' \cap F$  is a rectangular disk or two bi-gonal disks. If  $E = D' \cap F$  is a rectangular disk, then  $|A \cap F| > 1$  and  $A$  is isotopic to the annulus obtained by replacing  $D$  by  $E$ , using the 3-ball  $B$  bounded by the sphere  $D \cup D'$  derived from the

irreducibility of  $M'$ . If  $|A \cap F| > 1$ , then by a slight isotopy, we can reduce  $|A \cap F|$  and this contradicts the minimality of  $|A \cap F|$ . If  $E = D' \cap F$  is bi-gonal two disks, then components of  $E$  becomes to a  $\partial$ -compression disk of  $A$  and  $A$  is inessential. If  $A \cap F = \emptyset$ ,  $A$  is  $\partial$ -parallel in  $M$  and since  $F$  has no annular component, the parallel annulus in  $\partial M$  does not contain any component of  $F_i$ . and thus  $A$  is also  $\partial$ -parallel in  $M'$ .  $\square$

The following lemmas are obtained by a standard cut-and-paste argument similar to Lemmas 1.2.1, 1.2.2, [56, Lemma 3.1] and [56, Lemma 3.3].

**Lemma 1.2.3.** *Let  $M$  be an irreducible 3-manifold. Let  $F_1$  and  $F_2$  be disjoint homeomorphic surfaces in  $\partial M$  such that  $\partial M - (\partial F_1 \cup \partial F_2)$  is incompressible and for each  $\partial$ -reducing disk  $D$  of  $M$ ,  $|\partial D \cap (\partial F_1 \cup \partial F_2)| > 2$ . Then the manifold obtained by identifying  $F_1$  and  $F_2$  is irreducible and  $\partial$ -irreducible.*  $\square$

**Lemma 1.2.4.** *Let  $M_1$  be an irreducible,  $\partial$ -irreducible, atoroidal 3-manifold and let  $M_2$  be an irreducible,  $\partial$ -irreducible, atoroidal, and anannular 3-manifold. Let  $F_1$  and  $F_2$  be homeomorphic components of  $\partial M_1$  and  $\partial M_2$  respectively with negative Euler characteristics, such that there is no essential annulus  $A$  in  $M_1$  with  $\partial A \subset \partial M_1 - F_1$ . Then the manifold  $M$  obtained by identifying  $F_1$  and  $F_2$  is simple.*  $\square$

**Lemma 1.2.5.** *Let  $M$  be a simple 3-manifold. Let  $F_1$  and  $F_2$  be homeomorphic subsurfaces in  $\partial M$  such that each component of  $F_i$  is incompressible and has negative Euler characteristic. Then the manifold obtained by identifying  $F_1$  and  $F_2$  is simple.*  $\square$

**Lemma 1.2.6.** *Let  $M$  be an irreducible 3-manifold. Let  $F_1$  and  $F_2$  be disjoint homeomorphic surfaces in  $\partial M$  such that  $\partial M - (\partial F_1 \cup \partial F_2)$  is incompressible and for each  $\partial$ -reducing disk  $D$  of  $M$ ,  $|\partial D \cap (\partial F_1 \cup \partial F_2)| > 2$ . Then the manifold obtained by identifying  $F_1$  and  $F_2$  is irreducible and  $\partial$ -irreducible.*  $\square$

**Lemma 1.2.7.** *Let  $M_1$  be an irreducible,  $\partial$ -irreducible, atoroidal 3-manifold and let  $M_2$  be an irreducible,  $\partial$ -irreducible, atoroidal, and anannular 3-manifold. Let  $F_1$  and  $F_2$  be homeomorphic components of  $\partial M_1$  and  $\partial M_2$  respectively with negative Euler characteristics, such that there is no essential annulus  $A$  in  $M_1$  with  $\partial A \subset \partial M_1 - F_1$ . Then the manifold  $M$  obtained by identifying  $F_1$  and  $F_2$  is simple.*  $\square$

**Lemma 1.2.8.** *Let  $M$  be a simple 3-manifold. Let  $F_1$  and  $F_2$  be homeomorphic subsurfaces in  $\partial M$  such that each component of  $F_i$  is incompressible and has negative Euler characteristic. Then the manifold obtained by identifying  $F_1$  and  $F_2$  is simple.*  $\square$

Later we call sufficient conditions in these lemmas “gluing conditions”.

The following is a consequence of Myers’ argument [57, Theorem 1.1] or Kawauchi’s imitation technique [35, Theorem 1.1].

**Lemma 1.2.9.** *Let  $M$  be a 3-manifold with non-empty boundary, without spherical boundary component. From a given Heegaard decomposition of  $M$ , a properly embedded arc  $\tau$  with simple exterior  $E(\tau)$  can be constructed.  $\square$*

## Chapter 2

# Universal finiteness results on genus one hyperbolic knots

JSJT-decomposition (Jaco, Shalen, Johanson, and Thurston) is a unique decomposition of Haken manifolds into Seifert fibered manifolds and hyperbolic manifolds, which are called *JSJT-pieces*. As is known that all but finitely many Dehn surgeries on a hyperbolic knot produce hyperbolic manifolds [70], Dehn surgery on hyperbolic knots yielding non-hyperbolic manifolds is an interesting subject in knot theory. In this note, we describe some obstruction to construct a hyperbolic knot producing a manifold with a large number of JSJT-pieces by Dehn surgeries. It is not hard to construct a non-hyperbolic knot yielding a 3-manifold with a large number of JSJT-pieces. The following question was raised by K. Motegi:

**Question 2.0.10.** *Does there exist an upper bound on the number of JSJT-pieces of manifolds which are obtained by Dehn-surgery on hyperbolic knots in  $S^3$ ?*

As an approach to this question, we describe a difficulty in producing a large number of mutually disjoint incompressible tori by Dehn surgery on a knot. Our result is as follows.

**Theorem 2.0.11.** *Let  $K$  be a genus one hyperbolic knot in  $S^3$ . Then  $K$  bounds at most seven mutually disjoint non-parallel genus one Seifert surfaces.*

## 2.1 Preliminaries

### 2.1.1 Definitions

A *knot*  $K$  in a 3-manifold  $M$  is an embedded circle in  $M$ , and a *Seifert surface*  $S$  for  $K$  is an orientable connected surface embedded in  $M$  such that  $S \cap K = \partial S = K$ . It is well-known that any knot in an integral homology sphere has a Seifert surface. The *genus* of  $K$  is the least genus of Seifert surfaces for  $K$ .



For a subspace  $Y$  in  $M$ , we denote a regular neighborhood of  $Y$  in  $M$  by  $N(Y; M)$  (or simply  $N(Y)$ ), and the exterior  $M - \overset{\circ}{N}(Y)$  by  $E(Y)$ .

It is known that a Haken 3-manifold is uniquely decomposed by a union of essential tori into Seifert fibered spaces and simple manifolds (see [32, Chapter IX]), and the simple manifolds admit complete hyperbolic structures of finite volume ([70]). We call this decomposition *JSJT-decomposition*.

Here we state fundamental results on 3-dimensional topology needed later.

**Lemma 2.1.1** ([21, Theorem 5.2]). *Let  $M$  be an irreducible 3-manifold with a connected non-empty boundary  $\partial M$ . If  $\pi_1(M)$  is free, then  $M$  is a handlebody.*  $\square$

**Lemma 2.1.2.** *Let  $M$  be a 3-manifold and  $S$  be an orientable incompressible properly embedded surface in  $M$ . For each component  $M'$  of the cutting result along  $S$ , the induced homomorphism  $\pi_1(M') \rightarrow \pi_1(M)$  is injective.*

*Proof.* Suppose  $\pi_1(M') \rightarrow \pi_1(M)$  is not injective. Then there is a non-contractible loop  $l$  in  $M'$  which bounds a singular disk  $D$  in  $M$ . Since  $S$  is incompressible and two-sided in  $M$ , the induced homomorphism  $\pi_1(S) \rightarrow \pi_1(M)$  is injective ([21, Corollary 6.2]). We may assume  $S$  and  $D$  are in general position and  $D \cap S$  consists of circles. Let  $D_0$  be an innermost disk in  $D$  regarding  $D \cap S$ . Since  $S$  is  $\pi_1$ -injective,  $\partial D_0$  bounds a singular disk  $D'_0$  in  $S$ . We can replace  $D$  with  $D - D_0 \cup D'_0$  and homotope it slightly so that  $D \cap S$  reduced. Repeating this process, we can find a singular disk for  $l$  in  $M'$ . This is a contradiction.  $\square$

**Lemma 2.1.3.** *Let  $V$  be a handlebody and  $S$  be a properly embedded orientable surface in  $V$ . If  $S$  is incompressible in  $V$ , then each component  $V'$  of the cutting result along  $S$  is a handlebody.*

*Proof.* If  $V'$  is reducible, then some 2-sphere  $E$  does not bound a 3-ball in  $V'$ . However  $E$  bounds a 3-ball  $C$  in  $V$  since  $V$  is irreducible. This is impossible since  $V$  has non-empty boundary. Hence  $V'$  is irreducible. Now by Lemma 2.1.1, it is sufficient to show that  $\pi_1(V')$  is free. This follows by Lemma 2.1.2 and the well-known fact that any subgroup of a free group is free.  $\square$

## 2.1.2 Lyon's argument

Here we recall some argument given in [51] which inspires some interesting properties of genus one Seifert surfaces for knots.

**Lemma 2.1.4.** *Let  $F$  be a closed surface of positive genus. Let  $M$  be a 3-manifold obtained from a product  $F \times I$  by attaching 1-handles  $I \times D^2$ 's on  $F \times \{0\}$ . Then  $F \times \{1\}$  is incompressible in  $M$ .*

*Proof.* Let  $D$  be a compression disk of  $F \times \{1\}$ . By an innermost argument, we may assume  $D$  does not intersect any core  $\{1/2\} \times D^2$  of attached 1-handles. Thus  $D$  is contained in  $F \times I$  which is  $\partial$ -irreducible. This is a contradiction.  $\square$

**Lemma 2.1.5.** *Let  $M$  be an irreducible 3-manifold such that  $\partial M$  is a closed surface of genus two. If  $\partial M$  is compressible, then  $M$  is a handlebody, or  $M$  contains an incompressible torus.*

*Proof.* Let  $D$  be a compression disk of  $\partial M$  and suppose  $M$  does not contain incompressible tori.

Suppose  $D$  separates  $M$ . Let  $T_1$  and  $T_2$  be toroidal components of  $\partial N(\partial M \cup D)$ . Notice that  $N(\partial M \cup D)$  is obtained from  $(T_1 \cup T_2) \times I$  by attaching a 1-handle dual to  $D$ . By Lemma 2.1.4,  $T_1$  and  $T_2$  are incompressible in  $N(\partial M \cup D)$ . Thus, by an innermost argument, at least one, say  $T_1$ , is compressible in  $M - \mathring{N}(\partial M \cup D)$ . Let  $D'$  be a compression disk of  $T_1$  in  $M - \mathring{N}(\partial M \cup D)$ . It is easy to see that  $\partial D'$  is isotopic in  $N(\partial M \cup D)$  to a non-separating curve in  $\partial M$  and since  $\partial D'$  does not separate  $T_1$ , we may assume that  $\partial M$  has a compression disk which does not separate  $M$ .

Let  $D$  be a compression disk of  $\partial M$  which is non-separating in  $M$ . Put  $M' = N(\partial M \cup D)$ . Let  $T$  be the toroidal component of  $\partial M'$ . Notice  $T$  is incompressible in  $M'$  by Lemma 2.1.4. By the atoroidal assumption on  $M$  and an innermost argument,  $T$  is compressible in the closure of  $M - M'$ . Let  $E$  be a sphere obtained by compressing  $T$  into  $M - M'$ . Since  $M$  is irreducible and has a boundary,  $E$  bounds a 3-ball  $C$  on the side not containing  $T$ . Hence the closure of  $M - M'$  is a solid torus. Thus,  $M = M' \cup N(\partial M \cup D)$  is a handlebody.  $\square$

This argument was appeared in the proof of the following result [51, Theorem 3] which was used in showing the existence of a closed incompressible surface in the knot complement of some genus one simple knot in  $S^3$ . Now the following is also available.

**Theorem 2.1.6.** *Let  $K$  be a genus one knot in a 3-manifold  $M$  with  $E(K)$  simple. Let  $S$  be a Seifert surface of genus one. If  $E(S)$  is not a handlebody, then  $\partial E(S)$  is incompressible in  $M - K$ .*  $\square$

See [51, Theorem 3] for more observations.

## 2.2 Universal bounds for genus one knots

Theorem 2.0.11 follows from the following theorem.

**Theorem 2.2.1.** *Let  $M$  be a rational homology 3-sphere without genus two closed incompressible surfaces. Any genus one hyperbolic knot  $K$  in  $M$  bounds at most seven mutually disjoint, non-parallel, genus one Seifert surfaces.*

We divide the argument into two stages.

**First stage:** We consider a bound on the number of Seifert surfaces for knots in the boundary of a handlebody of genus two.

**Lemma 2.2.2.** *Let  $V$  be a handlebody of genus two, and let  $J$  be an essential simple closed curve which separates  $\partial V$ . Then,  $J$  bounds at most four mutually disjoint, non-parallel, genus one incompressible surfaces in  $V$ .*

This estimate is sharp. (See Figure 2.9 and §2.4) We will prove this in the second stage later.

An essential simple closed curve in  $\partial V$  is said to be of type  $((p, q), (r, s))$  if it is obtained by a plumbing two solid torus with annuli of types  $(p, q)$  and  $(r, s)$  respectively. An example of a  $((2, 3), (2, 3))$ -curve  $J_3$  is illustrated in Figure 2.2.

Let  $T$  be a properly embedded genus one incompressible surface in  $V$  with  $\partial T = J$ . Simply we call it a once punctured torus in  $V$ . In this case, each component of  $\partial V - \partial T$  is incompressible in  $V$  since if not, it is compressed to a disk, and since  $V$  is a handlebody and  $T$  is incompressible, it is noticed that  $T$  is  $\partial$ -compressible in  $V$ .

**Lemma 2.2.3.** *Suppose  $T$  is not  $\partial$ -parallel. Let  $V'$  be the closure of the component of  $V - T$  containing a  $\partial$ -compression disk for  $T$  in  $V$ . Then,  $V'$  is a handlebody of genus two and  $J = \partial T$  is a curve of type  $((1, 0), (p, q))$  for some  $(p, q)$  in  $V'$  where  $|p| > 1$ .*

*Proof.* Let  $D$  be a  $\partial$ -compression disk for  $T$ . By Lemma 2.1.3,  $V'$  is a handlebody. Since  $D$  is a  $\partial$ -compression disk, the arc  $\alpha = D \cap T$  is a properly embedded essential arc in  $T$ . Hence,  $\alpha$  is non-separating in  $T$  since  $T$  is a once-punctured torus. Now it is observed that the closure of  $V' - D$  is a single solid torus. Thus the conclusion holds. If  $|p| = 1$ , then it is easy to see that  $T$  is  $\partial$ -parallel.  $\square$

**Lemma 2.2.4.** *Any properly embedded incompressible surface  $S$  in  $V$  such that  $\partial S$  is a connected curve of type  $((1, 0), (p, q))$ ,  $|p| > 1$ , is  $\partial$ -parallel.*

*Proof.* Let  $D$  be an essential disk which is a meridian of  $V$  intersecting  $\partial S$  with two points transversely. Such a disk exists since  $\partial S$  is of type  $((1, 0), (p, q))$ . By an innermost argument and the incompressibility of  $S$ , we may assume that  $\beta = S \cap D$  is a single arc. We claim that both closures of  $D - \beta$  are  $\partial$ -compression disks for  $S$ . If not,  $S$  can be isotoped so that  $S \cap D = \emptyset$ , in particular,  $S$  is contained in the solid torus  $V - \mathring{N}(D)$ . Since a two-sided incompressible surface in a solid torus is homeomorphic to an annulus, this cannot occur as  $\partial S$  is connected. Thus, the claim follows.

Let  $S'$  be a surface obtained by a  $\partial$ -compression from  $S$  along the closure of a component of  $D - \beta$ . As we mentioned previously,  $S'$  is an annulus. Furthermore,  $S'$  is an annulus of type  $(p, q)$  in  $V' = V - \mathring{N}(D)$ . Hence,  $S'$  is  $\partial$ -parallel in  $V'$ . Now the  $\partial$ -parallelism can be extended to a  $\partial$ -parallelism of  $S$  in  $V$ .  $\square$

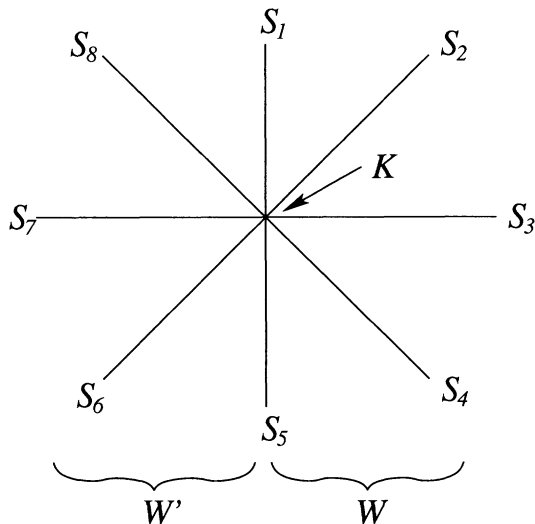

Figure 2.1:

*Proof of Lemma 2.2.2.* Suppose there are three mutually disjoint, non-parallel, genus one incompressible surfaces  $T_1$ ,  $T_2$  and  $T_3$  in  $V$  such that  $T_2$  is next to  $T_1$  and  $T_3$  and  $\partial T_1 = \partial T_2 = \partial T_3 = J$ . Since  $T_2$  is incompressible and  $V$  is a handlebody, it is  $\partial$ -compressible in  $V$ . Let  $D$  be a  $\partial$ -compression disk of  $T_2$  in the side  $V'$  containing  $T_1$ . Since  $T_1$  is incompressible, we may suppose  $D \cap T_1$  is a single arc. Thus  $D$  is a meridian disk of  $V'$  and  $J$  is of type  $((1, 0), (p, q))$  for some  $(p, q)$  with  $|p| > 1$ . By Lemma 2.2.4,  $T_1$  is parallel to  $T_2$  or  $\partial V$ . This is a contradiction.  $\square$

**Second stage:** Using Lemma 2.2.2 and Lemma 2.1.5, we prove Theorem 2.2.1.

*Proof of Theorem 2.2.1.* Suppose  $K$  bounds eight mutually disjoint non-parallel genus one Seifert surfaces  $S_1, \dots, S_8$  where  $S_i$  is next to  $S_{i\pm 1}$  (see Figure 2.1 for a local picture around  $K$ ). Put  $F = S_1 \cup S_5$  and denote the closures of components of  $M - F$  by  $W$  and  $W'$ . The surface  $F$  is a closed surface of genus two in  $M$ . Since  $M$  does not contain any closed incompressible surface of genus two, the surface  $F$  is compressible in  $M$ . Hence, we may assume  $\partial W$  is compressible in  $W$ .

*Claim 2.2.5.* The manifold  $W$  with the genus two boundary  $\partial W = S_1 \cup S_5$ , is irreducible and atoroidal.

*Proof.* Because  $K$  is hyperbolic, the complement  $M - K$  is irreducible and atoroidal. Hence any sphere in  $W$  bounds a 3-ball  $B$  in  $M - K$ , and because  $K$  is contained in  $\partial W = S_1 \cup S_5$ , it follows that  $B$  is contained in the interior of  $W$ . Thus,  $W$  is irreducible. Suppose that  $W$  is toroidal and let  $T$  be an incompressible torus in  $W$ . Since  $M - K$  is hyperbolic,  $T$

is inessential in  $M - K$ . Hence (1):  $T$  bounds a solid torus  $H$  with core  $K$  or (2):  $T$  is compressible in  $M - K$ . (1): Since  $T$  is contained in  $W$ , Seifert surfaces contained in  $W'$  do not meet  $T$ . Thus, each  $S_i \subset W'$  is contained in  $H$ , and hence  $K$  is null-homologous in  $H$ . But since  $K$  is a core of  $H$ ,  $K$  is not null-homologous in  $H$ . This is a contradiction. (2): Let  $D$  be a compression disk for  $T$  in  $M - K$ . Since  $S_1$  and  $S_5$  are incompressible in  $M - K$ , we may choose  $D$  so that  $D \cap \partial W = \emptyset$ . Thus  $T$  is compressible in  $W$ .  $\square$

Now we can apply Lemma 2.1.5 for  $W$ . By the above claim, we can conclude  $W$  is a handlebody. However,  $K \subset \partial W$  bounds five mutually disjoint genus one Seifert surfaces in  $W$ , two of them are  $S_1$  and  $S_5$ , and other three are in  $\mathring{W}$ , say  $S_2, S_3, S_4$ . This contradicts Lemma 2.2.2.  $\square$

## 2.3 Constructions

### 2.3.1 Non-trivial JSJT-decompositions

Here we consider how to construct hyperbolic knots spanning a large numbers of mutually disjoint non-parallel genus one Seifert surfaces.

Let  $V$  be a handlebody of genus two. Let  $J$  be an essential simple closed curve on  $\partial V$  which separates  $\partial V$  such that both components of  $\partial V - J$  are incompressible in  $V$ . Examples of such  $J$  are illustrated in Figure 2.2.

The simple closed curve  $J_1$  in the figure bounds only one genus one incompressible surface because the sutured manifold  $(V, J_1)$  is a product. Observe that  $J_2$  bounds two mutually disjoint non-parallel genus one incompressible surfaces both of which are components of  $\partial V - J_2$ , and the manifold  $V(J_2)$  obtained by attaching a 2-handle  $D^2 \times I$  along  $J_2$  is homeomorphic to the exterior of the Whitehead link.

Here we construct one more example  $J_4$  as follows. Let  $l$  be a core of the right hand side handle of the pair  $(V, J_2)$ . Perform a non-trivial Dehn surgery along  $l$ . The resultant manifold is still a handlebody and we let  $J_4$  be the image of  $J_2$ . Observe that each  $J_3$  and  $J_4$  bounds mutually disjoint three non-parallel genus one incompressible surfaces in  $V$ , two of them are in the boundary  $\partial V$ , the other is described as a union of a central disk of  $V$  and two bands. In fact, the manifold  $V(J_3)$  is decomposed into two Seifert manifolds each of which has an annular base with one singularity and a regular fiber of one part intersects a regular fiber of the other part in a single point transversely. The manifold  $V(J_4)$  is decomposed into a hyperbolic link complement, actually Whitehead exterior, and a Seifert manifold as above.

Now we can show the following:

**Proposition 2.3.1.** *Let  $M$  be a closed 3-manifold. There exists a genus one hyperbolic knot which bounds three mutually disjoint, non-parallel, genus one Seifert surfaces.*

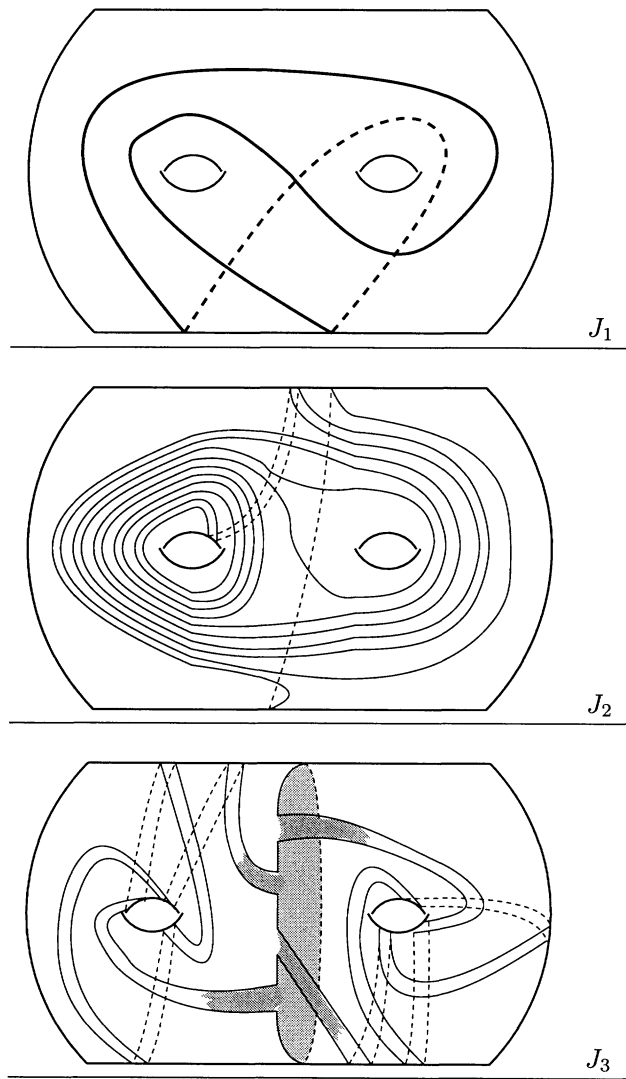

Figure 2.2:

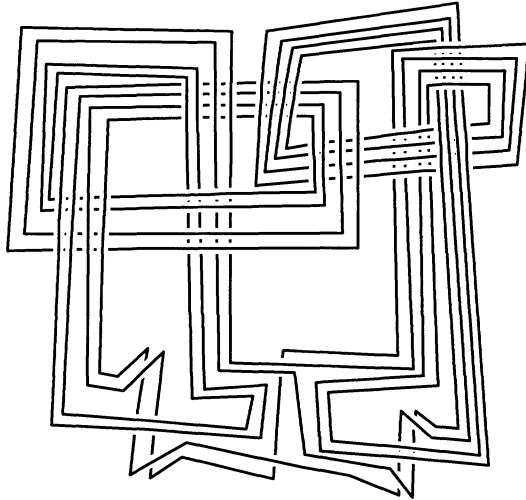

Figure 2.3:

This proposition is improved in §2.4, but we first give a proof of this version.

*Proof of Proposition 2.3.1.* We embed the handlebody  $V$  equipped with a separating essential curve  $J_i$  as above in a closed 3-manifold  $M$  so that  $E(V)$  is irreducible,  $\partial$ -irreducible, atoroidal, and anannular, here we denote the image of  $(V, J_i)$  by  $(V, K)$ . Such an embedding can be constructed by Myers' argument [57, Theorem 1.1]. We push  $J_i$  into  $\mathring{V}$  slightly and denote the image by  $J$ . Put  $M_1 = V - \mathring{N}(J)$ . By a cut and paste argument, we can show that  $(M_1, \partial M_1 - \partial N(J))$  satisfies the gluing condition of Lemma 1.2.4. By Lemma 1.2.4, we obtain a simple knot  $K$  in  $M$  which bounds three mutually disjoint, non-parallel, genus one Seifert surfaces.  $\square$

The knot  $K$  illustrated in Figure 2.3 is an example of hyperbolic knots obtained by Proposition 2.3.1. The exterior of the handlebody  $V$  is homeomorphic to the tangle space of true lover's tangle, which is simple [56, Proposition 4.1], and the curve  $J$  in  $\partial V$  is of type  $((2, 1), (2, 1))$ . According to a computation using SnapPea [84],  $K$  produces a closed 3-manifold by 0-surgery which admits JSJT-decomposition with three pieces, two of them are Seifert fibered and the other is hyperbolic.

### 2.3.2 Higher genus Seifert surfaces

For a universal bound on the number of mutually disjoint non-parallel incompressible Seifert surfaces, the condition "genus one" is necessary. In practice, we have:

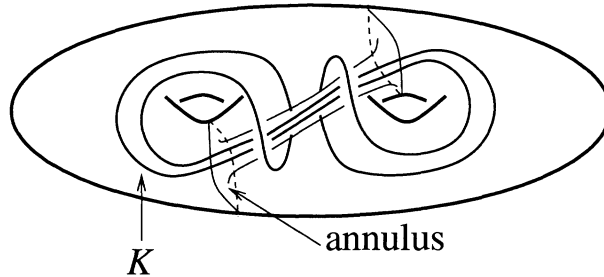

Figure 2.4:

**Theorem 2.3.2.** *For any integer  $n$ , there is a genus one hyperbolic knot  $K$  in  $S^3$  which bounds mutually disjoint incompressible Seifert surfaces  $S, F_1, \dots, F_n$  where  $S$  is genus one and  $F_i$  is genus two.*

*Proof.* The following is needed here.

**Lemma 2.3.3.** *Let  $K$  be the knot as shown in Figure 2.4 in a genus two handlebody  $V$ . Then  $V - \mathring{N}(K)$  is irreducible,  $\partial$ -irreducible, atoroidal and there is no essential annulus  $A$  such that  $\partial A \subset \partial N(K)$ .*

*Proof.* By cutting  $V - \mathring{N}(K)$  along the annulus indicated in the figure, it is noticed that  $V - \mathring{N}(K)$  is obtained as follows: Let  $V_0$  be a genus two handlebody and let  $K_0$  be the knot in  $V_0$  as shown in Figure 2.5, which is obtained by pushing the suture of a product sutured handlebody of genus two slightly in the interior of the handlebody. Let  $\gamma_1$  and  $\gamma_2$  be two simple closed curves as shown in Figure 2.5. Now it can be seen that the manifold obtained by identifying two annuli  $A_1 = N(\gamma_1; \partial V_0)$  and  $A_2 = N(\gamma_2; \partial V_0)$  in  $\partial V_0$  is homeomorphic to  $V - \mathring{N}(K)$ .

Let  $S_0$  be a genus one surface with connected boundary. Since  $V_0 - \mathring{N}(K_0)$  is obtained from the product sutured handlebody as above, it is obtained from an  $S^1 \times S^1 \times I$  and a product  $S_0 \times I$  by gluing  $\partial S_0 \times I$  to an incompressible annulus in  $\partial(S^1 \times S^1 \times I)$ . By a cut and paste argument, we can show that  $V_0 - \mathring{N}(K_0)$  is irreducible,  $\partial$ -irreducible, atoroidal and there is no essential annulus having boundaries in  $\partial N(K_0)$ . Furthermore, it follows that  $A_1$  and  $A_2$  is incompressible, each  $\gamma_i$  is not homotopic to a curve in  $\partial N(K_0)$  and  $\gamma_1$  is not homotopic to  $\gamma_2$ . Thus there is no essential annulus in  $V_0 - \mathring{N}(K_0)$  with boundaries in  $\partial N(K_0) \cup A_1 \cup A_2$ .

Let  $A$  be the essential annulus in  $V - \mathring{N}(K)$  which is the identified annulus of  $A_1$  and  $A_2$  and we regard  $(V - \mathring{N}(K)) - \mathring{N}(A)$  as  $V_0 - \mathring{N}(K_0)$ . By Lemma 1.2.3,  $V - \mathring{N}(K)$  is irreducible and  $\partial$ -irreducible. Let  $T$  be an essential annulus in  $V - \mathring{N}(K)$  with  $\partial T \subset \partial N(K)$  or an essential torus in  $V - \mathring{N}(K)$ . By a cut and paste argument, we may assume that  $T \cap A$  consists of essential loops in  $T$  and each component of  $T - \mathring{N}(A)$  is an essential annulus



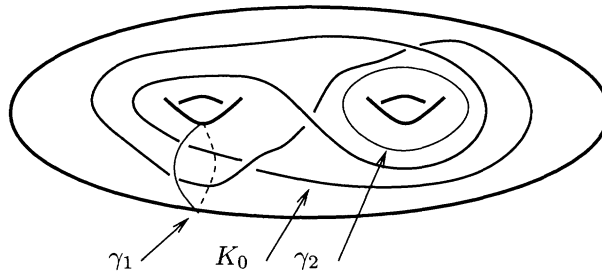

Figure 2.5:

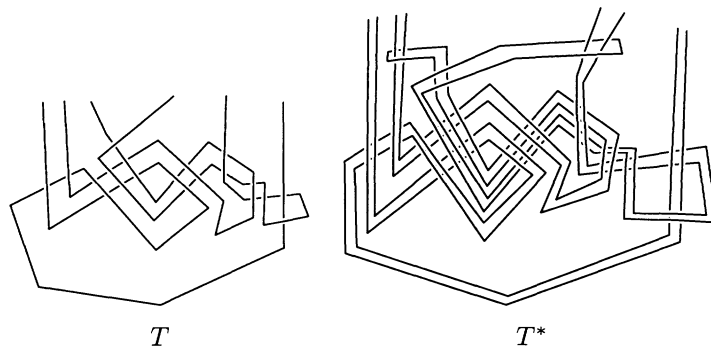

Figure 2.6:

in  $V_0 - \mathring{N}(K_0)$ . However as we have mentioned above,  $V_0 - \mathring{N}(K_0)$  does not contain an essential annulus with boundaries in  $\partial N(K_0) \cup A_1 \cup A_2$ . This completes the proof.  $\square$

We embed the pair  $(V, K)$  in  $S^3$  in a suitable way so that the image of  $K$  is a desired hyperbolic knot as will be explained below.

Tangle  $(M; t)$  means a pair of 3-manifold  $M$  and a properly embedded 1-dimensional manifold  $t$  in  $M$ . We say  $(M; t)$  is *simple* if the tangle space  $M - \mathring{N}(t)$  is irreducible,  $\partial$ -irreducible, atoroidal and anannular.

Let  $H = (S^2 \times I; u_1, u_2, u_3, u_4)$  be a simple 4-string  $(S^2 \times I)$ -tangle and  $R = (B^3; v_1, v_2)$  be a simple 2-string tangle, where each  $u_i$  and  $v_j$  is a connected arc. Let  $H^*$  and  $R^*$  denote tangles having a parallel string to each string of  $H$  and  $R$  respectively. Let  $T$  and  $T^*$  be tangles illustrated in Figure 2.6 respectively.

Using  $T^*$ ,  $n$  copies  $H_1^*, \dots, H_n^*$  of  $H^*$ , and  $R^*$ , we construct a genus one knot as shown in Figure 2.7 by connecting strings in a suitable way.

Here we remark that each examples of  $H$ ,  $R$  and  $T$  is based on the Suzuki's Brunnian  $\theta_m$ -graph, which is known to have hyperbolic exterior with totally geodesic boundary [81].

**Lemma 2.3.4.** *The genus one knot  $K$  is simple.*

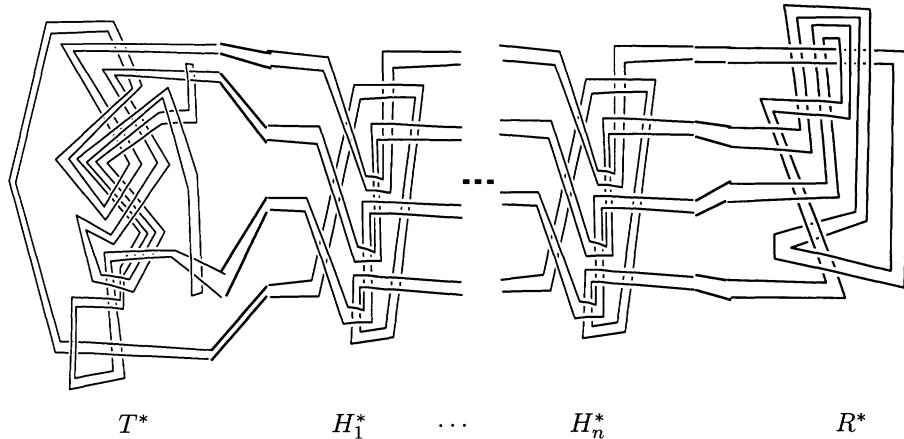

Figure 2.7:

*Proof.* It is observed that the ambient manifold  $S^3$  is decomposed into  $V$  and  $W$  along a closed surface of genus two, where  $V$  is a genus two handlebody containing  $K$  viewed as Figure 2.4 and  $W$  is a 3-manifold obtained from the tangle spaces of  $T$ ,  $n$  copies  $H_1, \dots, H_n$  of  $H$ 's and  $R$ . By Lemma 1.2.5,  $W$  is simple. Thus, by Lemma 1.2.4,  $K$  is simple in  $S^3$ . A genus one Seifert surface  $S$  is obtained by peripheral tubing from an obvious disk with two ribbon singularities. Since  $K$  is non-trivial, it is incompressible.  $\square$

Genus two Seifert surfaces  $F_i$ 's are shown in Figure 2.8 schematically, each of which is obtained from an obvious disk with two ribbon singularities by peripheral tubing and swallowing  $H_{i+1}^*, \dots, H_n^*$  and  $R^*$ . Now it is not hard to see  $S, F_1, \dots, F_n$  can be put mutually disjoint. Since the tangle space of  $H$  is simple, it is observed that each  $F_i$  and  $F_j$  are non-parallel.

Hereafter we show  $\partial N(F_i; S^3)$  is incompressible in  $S^3 - K$ . The exterior  $E(F_i)$  is decomposed along annuli in the tubes into 3-manifolds  $W_1$  and  $W_2$ , where  $W_1$  is obtained from tangle spaces of  $T$  and  $H_1, \dots, H_i$  and  $W_2$  is obtained from tangle spaces of  $H_{i+1}, \dots, H_n$  and  $R$ . By Lemma 1.2.5,  $W_1$  and  $W_2$  are simple. Clearly the decomposing annuli are essential and by Lemma 1.2.3,  $E(F_i)$  is irreducible and  $\partial$ -irreducible. Thus,  $F_i$  is incompressible.  $\square$

## 2.4 More on Proposition 2.3.1

As an approach to Question 2.0.10, it is natural to ask:

**Question 2.4.1.** *For any natural number  $n$ , does there exist a handlebody  $V$  and a simple closed curve  $J$  in  $\partial V$  such that  $V(J)$  contains more than  $n$  mutually disjoint, non-parallel essential tori?*

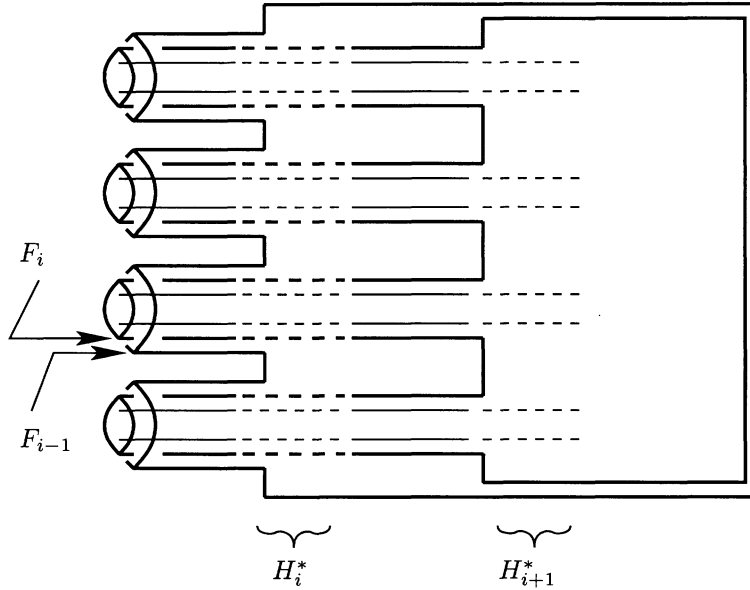

Figure 2.8:

If this question is affirmative, then for any natural number  $n$ , we can construct a hyperbolic knot  $K$  in  $S^3$  that produces a toroidal 3-manifold with more than  $n$  mutually disjoint, non-parallel essential tori by an integral surgery, by embedding  $(V, J)$  in  $S^3$  suitably.

T. Kobayashi had pointed out that Proposition 2.3.1 is sharp using techniques developed in [39] and [40]. Actually, the curve  $J$  in  $\partial V$  illustrated in Figure 2.9 bounds four non-isotopic genus one incompressible surfaces, two of them are in  $\partial V$ , and the others are essential in  $V$ . By embedding such  $(V, J)$  in a closed 3-manifold in a suitable way, we obtain the following.

**Theorem 2.4.2.** *Let  $M$  be a closed 3-manifold. There exists a genus one hyperbolic knot in  $M$  with four mutually disjoint, non-parallel, genus one Seifert surfaces.*  $\square$

We consider what will happen to hyperbolic knots with five genus one Seifert surfaces.

**Proposition 2.4.3.** *Let  $M$  be a non-Haken 3-manifold. If a hyperbolic knot  $K$  bounds five mutually disjoint, non-parallel, genus one Seifert surfaces, then the tunnel number of  $K$  is less than seven, and the Heegaard genus of  $M$  is less than seven.*  $\square$

**Proposition 2.4.4.** *Let  $K$  be a hyperbolic knot in a non-Haken 3-manifold  $M$ . If  $K$  bounds seven mutually disjoint, non-parallel genus one Seifert surfaces, then the 0-surgery manifold is a graph manifold with the  $(*)$ -decomposition with each piece Seifert fibered over the annulus with a single exceptional fiber.*  $\square$

Techniques used in the proofs of these results enable us to show the following.

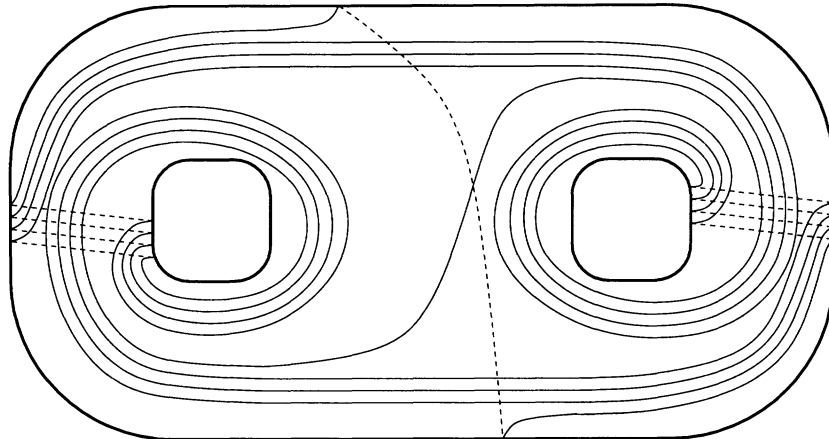

Figure 2.9:

**Theorem 2.4.5.** *Let  $M$  be a non-Haken 3-manifold. Any genus one small knot in  $M$  bounds at most three mutually disjoint, non-parallel, genus one Seifert surfaces.*  $\square$

### 2.4.1 Examples of double-torus knots

Let  $V$  be a handlebody of genus two. A closed 1-dimensional manifold  $J$  in  $\partial V$  is of type  $T(a, b)$  if it is carried by train track  $\tau$  illustrated in Figure 2.10 with the weight indicated in the figure. We let  $J_{a,b}$  denote a curve of type  $T(a, b)$ .

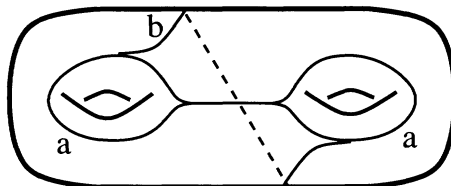

Figure 2.10:

The number of components of  $J_{a,b}$  coincides with  $\gcd(a, b)$ . In the case when  $\gcd(a, b) = 1$ ,  $J$  is separating in  $\partial V$  if  $a$  is even, otherwise  $J$  is non-separating.

**Proposition 2.4.6.** *Let  $a, b$  be co-prime integers.  $V(J_{a,b})$  is homeomorphic to the exterior of two-bridge knot/link of type  $(a, b)$ .*  $\square$

*Remark 2.4.7.* In the case when  $b = 1$ ,  $V(J_{a,b})$  is the exterior of  $(2, a)$ -torus knot/link.

Examples of  $K((8, 3), p_1, p_2)$  are obtained from the link illustrated in Figures 2.11. We

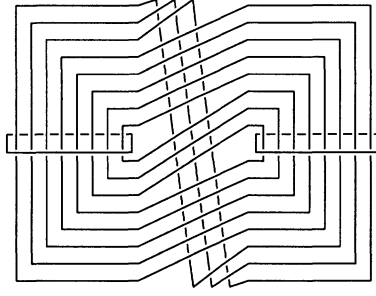

Figure 2.11:

embed  $(V, J_{a,b})$  in  $S^3$  “standardly” and perform  $p_i$ -full twists along each handles of  $V$ , here we denote the image of  $V$  by the same symbol  $V$ . Denote the image of  $J_{a,b}$  by  $K((a, b), p_1, p_2)$ .

**Proposition 2.4.8.** *If  $a > 2$  is even and  $p_1, p_2 \neq 0$ , then  $K((a, b), p_1, p_2)$  is hyperbolic.  $\square$*

*Remark 2.4.9.*  $K((2, 1), 1, 1)$  is the trefoil knot, and  $K((2, 1), -1, 1)$  is the figure-eight knot.  $K((3, 1), -1, 1)$  is not hyperbolic.

By  $A(n)$ , we mean a Seifert fibered manifold of annular base with  $n$  singular fibers. For a 3-manifold  $M$  with the torus decomposition  $M = E_1 \cup \dots \cup E_n \cup M_1 \cup \dots \cup M_m$  where  $E_1, \dots, E_n$  are knot/link exteriors and  $M_1, \dots, M_m$  are Seifert fibered manifolds, such that:

- if  $E_i \cap E_j \neq \emptyset$ , then the meridian loop of  $E_i$  is identified with the meridian loop of  $E_j$  on each component of  $E_i \cap E_j$ ,
- if  $E_i \cap M_j \neq \emptyset$ , then the meridian loop of  $E_i$  is identified with the regular fiber of  $M_j$  on each component of  $E_i \cap M_j$ ,
- if  $M_i \cap M_j \neq \emptyset$ , then the regular fiber of  $M_i$  intersects the regular fiber of  $M_j$  in a single point transversely on each component of  $M_i \cap M_j$ ,

the torus decomposition is called  $(*)$ -decomposition.

Now we can see the followings.

**Proposition 2.4.10.** *If  $a$  is even,  $|p_1| > 1$  and  $|p_2| > 1$ , then  $K$  is a hyperbolic knot and bounds four genus one Seifert surfaces which are mutually disjoint, and  $K(0)$  admits the  $(*)$ -torus decomposition as shown in Figure 2.12-(A).  $\square$*

**Proposition 2.4.11.** *If  $a$  is odd,  $|p_1| > 1$  and  $|p_2| > 1$ , then  $K(p_1 - (-1)^b p_2)$  admits the  $(*)$ -torus decomposition as shown in Figure 2.12-(B).  $\square$*

For example,  $K((4, 1), 2, 2)$  illustrated in Figure 2.9 is a hyperbolic double-torus knot such that the 0-surgery manifold is a graph manifold which admits the  $(*)$ -torus decomposition

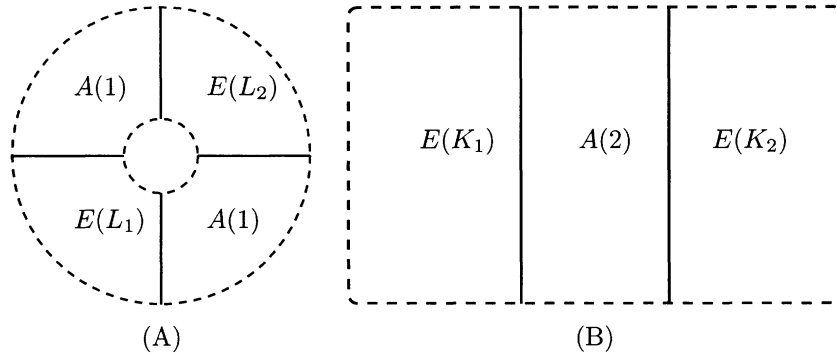

Figure 2.12:

of four  $A(1)$ -pieces. For odd number  $a$ , and suitably chosen numbers  $p_1, p_2$ ,  $K((a, b), p_1, p_2)$  is a double torus hyperbolic knot such that the  $(p_1 - (-1)^b p_2)$ -surgery manifold  $M$  has the  $(*)$ -torus decomposition as shown in Figure 2.12-(B), and  $M$  admits infinitely many isotopy classes of essential tori.

## Chapter 3

# Accidental essential surfaces and excellent Seifert surfaces

### 3.1 Review of accidental surfaces

This section is devoted to a survey on accidental surfaces based on [25].

#### 3.1.1 Definitions

Let  $K$  be a knot in the 3-sphere  $S^3$ , and  $F$  a properly embedded surface in the exterior  $E(K)$  of  $K$  in  $S^3$ . A non-trivial loop  $l$  in  $F$  is called an *accidental peripheral* if it is freely homotopic into  $\partial E(K)$  in  $E(K)$  but not in  $F$ . Here, an annulus  $A$  connecting  $l$  and a loop  $l'$  in  $\partial E(K)$  is called an *accidental annulus* for  $l$ . We define an *accidental surface* as such surface  $F$  with an accidental peripheral. The existence of an accidental peripheral causes that  $i_*(\pi_1(F))$  contains an element which is conjugate to some element of the peripheral subgroup  $\pi_1(\partial M)$ . Thus, in the case that  $M$  is hyperbolic,  $\rho(i_*(\pi_1(F)))$  contains an accidental parabolic element, where  $\rho : \pi_1(M) \rightarrow PSL_2(\mathbb{C})$  is a faithful discrete representation.

#### 3.1.2 Accidental closed surfaces

In this section, we treat with accidental closed surfaces. Let  $S$  be an accidental closed surface in  $E(K)$ . According to Ichihara-Ozawa [22], all accidental annuli  $A$  determine the unique slope  $A \cap \partial E(K)$ . Moreover, if those slopes are non-meridional, then all accidental annuli are mutually isotopic *rel.*  $S \cup \partial E(K)$ . Thus, we can define the *accidental slope* of  $S$  as a loop  $A \cap \partial E(K)$  for an accidental annulus  $A$ . Furthermore, it is known that there is a meridional compression disk for  $S$  or  $K$  is isotopic onto  $S$ , according to the accidental slope is meridional or integral.

A properly embedded surface in  $E(K)$  with non-empty boundary is said to be *strongly essential* if  $F$  is essential and at least one component of  $E(K) - \overset{\circ}{N}(F; E(K))$  is  $\partial$ -irreducible. A Seifert surface is said to be *totally knotted* if it is strongly essential. A knot is called a *totally knotted knot* if it bounds a totally knotted Seifert surface.

**Theorem 3.1.1** ([22]). *The following are equivalent.*

1. *There exists an accidental closed surface with a separating accidental peripheral.*
2.  *$K$  is totally knotted.*

**Theorem 3.1.2** ([22]). *Mutually disjoint accidental closed surfaces have the same accidental slope.*

But, there exists a knot which has two accidental closed surfaces with accidental slopes 0 and  $\infty$ .

**Conjecture 3.1.3** ([22]). *All integral accidental slopes of accidental closed surfaces in a knot complement are coincident. (The knot illustrated in Figure 3.1 is a counterexample to this conjecture.)*

It is known that for toroidally alternating knots (this class includes all alternating knots and almost alternating knots), 3-braid knots and Montesinos knots, all closed incompressible surfaces in their complements are meridionally compressible. Hence, these knots satisfy Conjecture 3.1.3.

In [24], the following estimate was obtained.

**Theorem 3.1.4** ([24]). *Let  $S_1$  and  $S_2$  be accidental closed surfaces with accidental slopes  $\gamma_1$  and  $\gamma_2$ . Then*

$$\Delta(\gamma_1, \gamma_2) \leq \min\{-\chi(S_1), -\chi(S_2)\}.$$

When we were studying boundary slopes of non-orientable totally knotted Seifert surfaces [75], we constructed a counterexample to Conjecture 3.1.3. The knot illustrated in Figure 3.1 bounds two totally knotted non-orientable Seifert surfaces  $F_1$  and  $F_2$  with  $|\gamma(F_1) - \gamma(F_2)| = 2$ ,  $\chi(F_1) = -2$  and  $\chi(F_2) = -3$ . Thus, it admits two closed accidental surfaces  $S_1$  and  $S_2$  with integral accidental slopes  $\gamma_1$  and  $\gamma_2$  respectively, such that  $|\gamma_1 - \gamma_2| = 2$ ,  $\chi(S_1) = -4$ , and  $\chi(S_2) = -6$ . One can modify it so that it also admits an accidental surfaces of  $1/0$ -accidental slope. However, the best possibility of Theorem 3.1.4 is still unknown.

### 3.1.3 Accidental surfaces with boundary

In this section, we treat with accidental surfaces with non-empty boundary.

**Theorem 3.1.5** ([60]). *If  $E(K)$  contains accidental essential surface with boundary slope  $\gamma$ , then  $E(K)$  contains an accidental incompressible closed surface with accidental slope  $\gamma$ .*



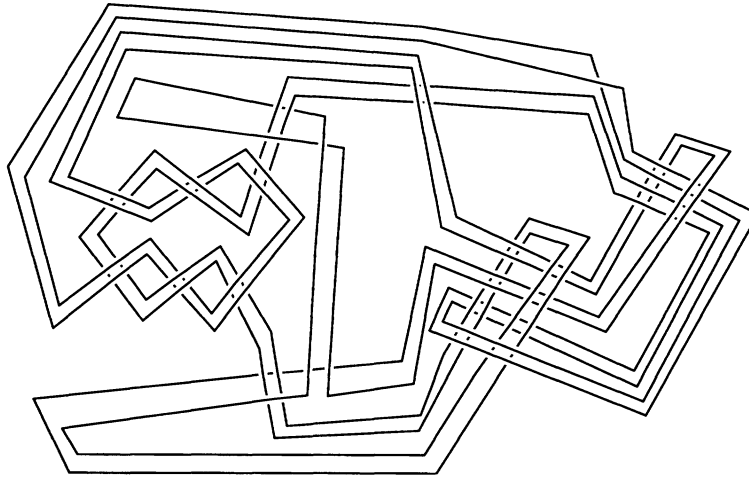

Figure 3.1:

### 3.1.4 Accidental Seifert surfaces

In [7], S. Fenley showed the following.

**Theorem 3.1.6** ([7]). *Any accidental Seifert surface is non-minimal.* □

On the other hand, we know:

**Theorem 3.1.7** ([60]). *Any accidental incompressible Seifert surface is totally knotted.* □

Then the following question is raised.

**Problem 3.1.8.** *Does there exist a knot which bounds an accidental incompressible Seifert surface?*

We obtain an affirmative answer to Problem 3.1.8.

**Theorem 3.1.9** ([76]). *In any closed 3-manifold, there exists genus one non-fibered hyperbolic knot which bounds an accidental incompressible Seifert surface of arbitrarily high genus.*

The knot illustrated in Figure 3.2 is a genus one hyperbolic in  $S^3$  with an accidental Seifert surface of arbitrarily high genus, constructed in [76].

A knot  $K$  is said to be *small* if  $E(K)$  contains no essential closed surface, and *large* if it is not small. It is known that many knots are large and that torus knots, 2-bridge knots and Montesinos knots with length three are small.

Obviously, knots whose complements contain an accidental closed surface are large. However, does the converse hold?

**Problem 3.1.10.** *Does a large knot always contain an accidental closed surface?*

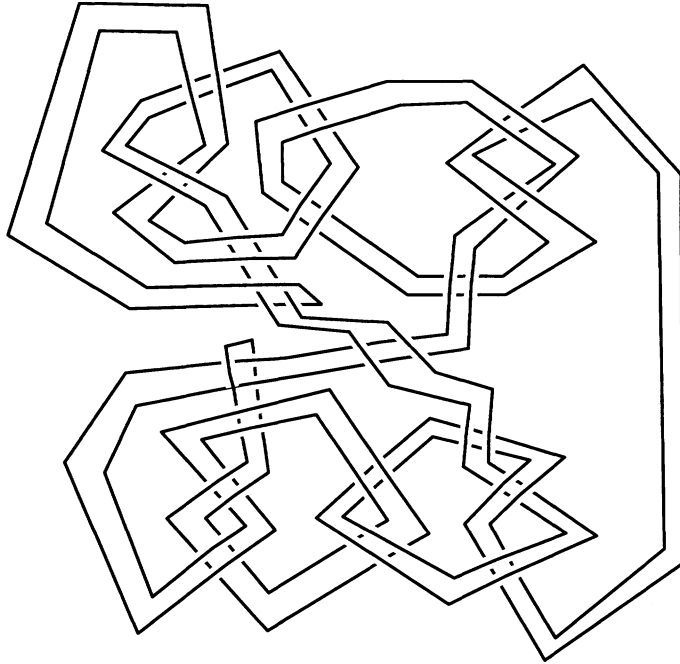

Figure 3.2:

### 3.2 Properties of accidental Seifert surfaces

We show that if there exists an essential accidental surface in the knot exterior, then a closed accidental surface also exists. As its corollary, we know boundary slopes of accidental essential surfaces are integral or meridional. It is shown that an accidental incompressible Seifert surface in knot exteriors in  $S^3$  is totally knotted. Examples of satellite knot with arbitrarily high genus Seifert surfaces with accidental peripherals are given, and a Haken 3-manifold which contains a hyperbolic knot with an accidental incompressible Seifert surface of genus one, is also given.

For a properly embedded surface  $S$  in a 3-manifold  $M$ , a non-trivial loop  $l$  in  $S$  is called *accidental peripheral* if  $l$  is freely homotopic into  $\partial M$  in  $M$  but not in  $S$ , and  $S$  having an accidental peripheral is said to be *accidental*. An annulus  $A$  such that  $A \cap S = \partial A \cap S = l$  and  $\partial A = l \cup l'$  where  $l'$  is an essential loop in  $\partial M$ , is called an *accidental annulus*.

Let  $K$  be a knot in the 3-sphere  $S^3$ . We denote the knot exterior  $S^3 - \mathring{N}(K)$  by  $E(K)$ . If  $S$  is a Seifert surface bounded by  $K$ , we denote  $S \cap E(K)$  by the same symbol  $S$  and if it is accidental, we say the Seifert surface  $S$  is accidental.

Fenley ([7]) proved that there exists no accidental Seifert surface of minimal genus by using the existence of a good Reebless foliation with that surface as compact leaf ([11]).

As its corollary, he showed that for any non-fibered hyperbolic knot, any lift of a minimal Seifert surface to the universal cover is a quasi-disk and its limit set is a quasi-circle in the sphere at infinity, by using Thurston's result ([70]). Thus, if a non-fibered hyperbolic knot  $K$  bounds an incompressible Seifert surface  $S$  which does not have embedded accidental peripherals, then  $S$  corresponds to a quasi-Fuchsian subgroup ([70]).

**Question 3.2.1.** *Does there exist a knot which bounds an accidental incompressible Seifert surface?*

*Remark 3.2.2.* The condition “incompressible” is necessary. In fact, any knot bound an accidental compressible Seifert surface. Indeed, one can construct an accidental Seifert surface by tubing any Seifert surface and a narrow torus parallel to the knot.

Here we prove that a large class of knots denies Question 3.2.1 and that some satellite knots bound accidental incompressible Seifert surfaces (Theorem 3.2.5).

Here, we remark that an existence of an accidental peripheral implies an existence of an embedded accidental annulus. In fact, if  $S$  has an accidental peripheral, then Annulus theorem ([32]) gives an accidental peripheral with an embedded accidental annulus (Lemma 3.2.6).

For a non-peripheral closed incompressible surface  $F$  embedded in  $E(K)$  with an accidental annulus  $A$ , the slope of  $A \cap \partial E(K)$  is called an *accidental slope*. It is known ([5]) that an accidental slope of a closed incompressible surface is an integer or  $1/0$ , and it was shown that  $F$  has a unique accidental slope. Furthermore if the accidental slope is integral, its accidental annulus is unique up to isotopy ([22]).

**Theorem 3.2.3 (Existence of closed accidental surface).** *Let  $K$  be a knot in  $S^3$ . If  $E(K)$  contains an accidental essential surface with boundary slope  $\gamma$ , then  $E(K)$  contains a closed accidental incompressible surface with accidental slope  $\gamma$ .*

By Theorem 3.2.3 and [5, Lemma 2.5.3], the following theorem holds.

**Theorem 3.2.4 (Integral or meridional).** *The boundary slope of an accidental essential surface is an integer or  $1/0$ .* □

In [22], it is conjectured that the integral accidental slope is unique for all accidental incompressible closed surfaces in  $E(K)$ . By Theorem 3.2.3, if this conjecture is true, we can conclude that the integral accidental boundary slope is unique.

A Seifert surface  $S$  is said to be *totally knotted* if the exterior  $S^3 - \mathring{N}(S; S^3)$  is  $\partial$ -irreducible. We say that  $K$  is *totally knotted* if  $K$  bounds a totally knotted Seifert surface. Notice that there exists a knot which does not bound a totally knotted Seifert surface. For example, if  $K$  is a fibered knot, then for an incompressible Seifert  $F$ , the exterior  $S^3 - \mathring{N}(F; S^3)$  is a handlebody which is a product  $F \times I$ , so it is not totally knotted.

As will be shown later, an accidental incompressible Seifert surface is totally knotted, hence the remaining case for Question 3.2.1 is of non-minimal, totally knotted Seifert surfaces. We can also show that totally knotted Seifert surfaces with some conditions are not accidental. However, there exists a satellite knot with totally knotted, non-minimal genus accidental Seifert surfaces.

**Theorem 3.2.5 (Accidental incompressible Seifert surfaces).** *There exist infinitely many genus one satellite knots, each of which bounds an accidental incompressible Seifert surface of arbitrarily high genus.*

This theorem gives a positive answer for Question 3.2.1. If the knot exterior  $E(K) = S^3 - \mathring{N}(K)$  contains no essential torus, the Thurston's geometrization theorem assures that  $E(K)$  is a Seifert manifold or  $S^3 - K$  admits a complete hyperbolic structure of finite volume. It is known that for a Seifert manifold with non-empty boundary, closed incompressible surface is isotopic to a torus which is a union of fibers ([32]). Hence, if  $E(K)$  is a Seifert manifold,  $K$  does not bound a totally knotted Seifert surface.

In section 3.3.1, we will construct a closed hyperbolic Haken 3-manifold which contains a hyperbolic knot with an accidental incompressible Seifert surface of genus one. Indeed our examples of Theorem 3.2.5 are satellite, namely, contain essential tori in exteriors, we could construct hyperbolic examples in arbitrary 3-manifolds and confirmed by J. Weeks' computer program 'SnapPea'.

### 3.2.1 Boundary slopes of essential accidental surfaces

In this section, we consider the existence of embedded accidental annulus and prove Theorem 3.2.3. Hereafter, all 3-manifolds are assumed to be orientable. For a surface  $S$  properly embedded in a 3-manifold  $M$ , we denote the regular neighborhood of  $S$  in  $M$  by  $N(S; M)$ , or simply  $N(S)$ . We denote the frontier of  $N(S; M)$  by  $\partial N(S; M)$ , and let  $\text{int}N(S; M)$  denote the topological interior of  $N(S; M)$  in  $M$ .

**Lemma 3.2.6 (Embedded accidental annulus).** *Let  $S$  be a two-sided surface properly embedded in a compact, irreducible,  $\partial$ -irreducible 3-manifold  $M$  with  $\partial M$  a union of some tori. If  $S$  is incompressible and  $\partial$ -incompressible in  $M$  and has an accidental peripheral, then there exists an embedded accidental annulus for  $S$ .*

*Proof.* Since  $S$  is accidental, there exists a map  $f : S^1 \times [0, 1] \rightarrow M$  generic to  $S$  such that  $f(S^1 \times \{0\})$  is an accidental peripheral  $l$  and  $f(S^1 \times \{1\}) \subset \partial M$ . By the hypothesis that  $S$  is two-sided incompressible and  $\partial$ -incompressible, we have  $\partial N(S)$  is incompressible and  $\partial$ -incompressible in  $M - \text{int}N(S)$ . Using the product structure of  $N(S)$  and the incompressibility and the  $\partial$ -incompressibility of  $\partial N(S)$ , we can modify  $f$  so that  $f^{-1}(S)$  contains only essential embedded loops in  $S^1 \times [0, 1]$  and we may assume that  $|f^{-1}(S)|$  is minimal among all accidental peripherals and such maps. Let  $A$  be the closure of a component of

$S^1 \times [0, 1] - f^{-1}(S)$  such that  $S^1 \times \{1\} \subset \partial A$ . If  $f(\partial A - S^1 \times \{1\})$  is not an accidental peripheral, then it is freely homotopic into  $\partial M$  in  $S$ . So, by cutting  $N(A; S^1 \times [0, 1])$  and pasting a parallel copy of the free homotopy in  $S$ , we obtain a map  $f' : S^1 \times [0, 1] \rightarrow M$  with  $|f'^{-1}(S)| < |f^{-1}(S)|$ , a contradiction to the minimality of  $|f^{-1}(S)|$ .

Let  $M'$  be the cutting result  $M - \text{int}N(S)$ , and let  $S^+$  be the component of  $\partial N(S)$  with  $S^+ \cap f(A) \neq \emptyset$ . Since each component of  $\partial M$  is a torus and  $S$  is essential,  $M'$  forms a sutured manifold. Set  $T' = \hat{N}(\text{Im}(f) \cap \partial M'; \partial M')$  where  $\hat{N}(\text{Im}(f) \cap \partial M'; \partial M')$  is the union of  $N(\text{Im}(f) \cap \partial M'; \partial M')$  and the disks bounded by  $\partial N(\text{Im}(f) \cap \partial M'; \partial M')$  in  $\partial M'$ . Then  $T'$  is incompressible in  $M'$ , so the pair  $(M', T')$  forms a Haken-manifold pair.

For  $f(S^1 \times \{1\})$  is in a suture, the component of  $\hat{N}(\text{Im}(f) \cap \partial M'; \partial M')$  which contains  $f(S^1 \times \{1\})$  is an annulus. By applying the Annulus theorem ([32, VIII.10]) to  $(M', T')$  we get a well-embedded Seifert pair  $(\Sigma, \Phi) \subset (M', T')$ . If the component  $(\Sigma', \Phi') \subset (\Sigma, \Phi)$  which contains  $\text{Im}(f)$  is an  $I$ -pair, then it has to be  $((S^1 \times I) \times I)$  and either get an embedded accidental peripheral or actual peripheral in  $S$ . Hence we assume that  $(\Sigma', \Phi')$  is an  $S^1$ -pair. If each component of  $\partial \Phi'$  is parallel to  $\partial S^+$  in  $S^+$ , the loop  $l$  is also parallel to  $\partial S^+$  in  $S^+$ . So, some component of  $\text{Fr}\Sigma'$  is an embedded accidental annulus for  $S^+$ . Since  $S$  is parallel to  $S^+$  in  $M$ , the embedded accidental annulus can be modified to an embedded accidental annulus for  $S$ .  $\square$

A surface  $F$  properly embedded in a 3-manifold  $M$  is  $\pi_1$ -essential if  $\partial N(F)$  is incompressible and  $\partial$ -incompressible in  $M - \hat{N}(F)$ . We will deal with one-sided surfaces, so we prove the following lemma needed later.

**Lemma 3.2.7.** *Let  $K$  be a non-trivial knot in  $S^3$ , and  $S$  be a properly embedded, connected, one-sided surface in  $E(K)$ . The surface  $S$  is  $\pi_1$ -essential if and only if  $\partial N(S)$  is incompressible in  $E(K)$ .*

*Proof.* Suppose  $\partial N(S)$  is incompressible in  $E(K)$ . We first claim that if  $\partial N(S)$  is  $\partial$ -compressible in  $E(K)$ , then  $\partial N(S)$  is  $\partial$ -parallel into  $\partial E(K)$  by the irreducibility of  $E(K)$  and the incompressibility of  $\partial N(S)$ . To see this, let  $D$  denote a  $\partial$ -compression disk of  $\partial N(S)$  in  $E(K)$  and let  $A$  be the annular component of  $\partial E(K) - N(S)$  which meets  $\partial D$ . Let  $D_+, D_-$  be components of  $\partial N(D; E(K) - \text{cl}(N(S)))$  which are parallel copies of  $D$ , and let  $D_*$  be the ‘‘rectangular’’ component of  $A - (D_+ \cup D_-)$  which does not meet  $\partial D$ . Put  $D' = D_* \cup D_+ \cup D_-$ . Observe that the surface  $D'$  is a disk with  $\partial D' \subset \partial N(S)$  and by the incompressibility,  $\partial D'$  bounds a disk in  $D''$  in  $\partial N(S)$ . Hence the component of  $\partial N(S)$  having the  $\partial$ -compression disk  $D$  is an annulus consisting of  $D''$  and  $N(\partial D \cap \partial N(S); \partial N(S))$ . Since the knot exterior  $E(K)$  is irreducible, the sphere  $D'' \cup D'$  bounds a 3-ball  $B$  in  $E(K)$ . Thus, the manifold  $B \cup N(D)$  forms a solid torus with meridian disk  $D$ , so this gives a  $\partial$ -parallelism.

Notice that the  $\partial$ -compression disk is in  $\text{cl}(E(K) - N(S))$  since for a twisted  $I$ -bundle over surface, the corresponding  $\partial I$ -bundle is  $\partial$ -incompressible in the twisted  $I$ -bundle. So,

$\partial N(S)$  is an annulus parallel into  $\partial E(K)$ . Thus the one-sided surface  $S$  is homeomorphic to a Möbius band and  $\pi_1(E(K)) = \pi_1(S) = \mathbb{Z}$ . This means that  $K$  is trivial.  $\square$

*Proof of Theorem 3.2.3.* Let  $S_0$  be a connected  $\pi_1$ -essential surface with boundary slope  $\gamma$ , and let  $A_0$  be an accidental annulus for  $S_0$ . By Lemma 3.2.6, we may assume the accidental annulus  $A_0$  is embedded. We construct (possibly non-orientable)  $\pi_1$ -essential surfaces  $\{S_i\}$  inductively as follows. We are given a  $\pi_1$ -essential surface  $S_i$  and an accidental annulus  $A_i$  for  $S_i$ . Let  $B_i$  be the closure of the component of  $\partial E(K) - \partial S_i$  which contains  $\partial A_i$ . We isotope the surface  $S_i \cup B_i$  slightly into  $\mathring{E}(K)$  and we set the resulting surface  $S_{i+1}$ . We put  $A_{i+1}$  the closure of the component of  $A_i - S_{i+1}$  which meets  $\partial E(K)$  and we set  $A'_i$  the closure of the other component. We put  $E(S_{i+1}) = \text{cl}(E(K) - N(S_{i+1}))$ . Here we denote  $A_{i+1} \cap E(S_{i+1})$  and  $A'_i \cap E(S_{i+1})$  by the same symbols  $A_{i+1}$  and  $A'_i$  respectively.

**Proposition 3.2.8.** *The surface  $S_{i+1}$  is  $\pi_1$ -essential in  $E(K)$  and  $A_{i+1}$  is an accidental annulus for  $S_{i+1}$ .*

*Proof of Proposition 3.2.8.* Suppose there exists a compression disk  $D$  for  $\partial N(S_{i+1})$  in  $E(S_{i+1})$ . Set  $A = A'_i \cup A_{i+1}$ . We may assume that  $D$  intersects  $A$  transversely, and assume that the number  $|D \cap A|$  is minimal among all compression disks for  $\partial N(S_{i+1})$  in  $E(S_{i+1})$ . If  $|D \cap A| = 0$ , then we have  $\partial D \subset \partial N(S_i)$ , but this contradicts the  $\pi_1$ -essentiality of  $S_i$ .

We note that  $A'_i$  and  $A_{i+1}$  are incompressible in  $E(S_{i+1})$ . Otherwise,  $K$  is trivial and  $S_0$  must be a disk. This contradicts the accidentality of  $S_0$ . Hence, there is no loop in  $D \cap A$  by the minimality of  $|D \cap A|$ .

Next, we will show that there exists no arc of  $D \cap A$  which is inessential in  $A$ . For a contradiction, suppose that there is an arc of  $D \cap A$  which is inessential in  $A$ . Let  $\alpha$  be an arc of  $D \cap A$  which is outermost in  $A$ , and  $\delta$  the corresponding outermost disk in  $A$ . Cutting  $D$  along  $\alpha$  and pasting two copies of  $\delta$  to them, we get two disks  $D_1$  and  $D_2$  properly embedded in  $E(S_{i+1})$ . It follows from the essentiality of  $\partial D$  in  $\partial E(S_{i+1})$  that at least one of  $D_1$  and  $D_2$  is a compression disk for  $\partial E(S_{i+1})$  in  $E(S_{i+1})$  again. We exchange  $D$  for the new compression disk. However,  $|D \cap A|$  strictly decreases, this contradicts the minimality of  $|D \cap A|$ .

Therefore, all arcs of  $D \cap A$  are essential in  $A$ . Let  $\alpha$  be an arc of  $D \cap A$  which is outermost in  $D$ , and  $\delta$  the corresponding outermost disk in  $D$ . Since one component of  $\partial A_{i+1}$  is contained in  $\partial E(K)$ ,  $|\delta \cap A_{i+1}| = 0$ . Now  $\delta$  gives a  $\partial$ -compression disk for  $A'_i$  in  $E(S_{i+1})$ . When we recover  $S_i$  from  $S_{i+1}$  by an annulus compression along  $A_{i+1}$ ,  $\delta$  can be converted to a  $\partial$ -compression disk for  $A_i$  in  $E(S_i)$ , since  $\delta \cap (E(S_{i+1}) \cap A'_i)$  consists of one point. This contradicts the assumption that  $A_i$  is an accidental annulus for  $S_i$ , and proves that  $\partial N(S_{i+1})$  is incompressible in  $E(K)$ .

If  $S_{i+1}$  is one-sided, then it is  $\pi_1$ -essential by Lemma 3.2.7. If  $S_{i+1}$  is two-sided and  $\partial N(S_{i+1})$  is  $\partial$ -compressible in  $E(K)$ , then  $S_{i+1}$  is  $\partial$ -parallel annulus. By the construction of  $S_{i+1}$ , we have  $\chi(S_{i+1}) = \chi(S_i)$  where  $\chi$  denoted the Euler number. It follows that  $S_i$

is also an annulus, but  $S_i$  cannot be accidental since all non-trivial loop is  $\partial$ -parallel. This proves that  $\partial N(S_{i+1})$  is  $\partial$ -incompressible in  $E(K)$ .

Now let us show that  $A_{i+1}$  is an accidental annulus. It is noticed that  $S_i$  is connected. If  $A_{i+1} \cap S_{i+1}$  is parallel to  $\partial S_{i+1}$  in  $S_{i+1}$ , then  $S_i$  cannot be connected by the existence of the parallelism annulus in  $S_{i+1}$ . Hence,  $A_{i+1}$  is an accidental annulus for  $S_{i+1}$ . This completes the proof of Proposition 3.2.8.  $\square$

Since  $|\partial S_{i+1}| = |\partial S_i| - 2$ , we have  $|\partial S_n| = 0$  or  $1$  for some integer  $n$ . If  $|\partial S_n| = 0$ , we are done. If  $|\partial S_n| = 1$ , the surface  $S_{n+1} = \partial N(S_n \cup N(K))$  is  $\pi_1$ -essential and accidental by the same argument as Proposition 3.2.8 since  $\partial N(S_n; E(K))$  is  $\pi_1$ -essential and accidental. This proves Theorem 3.2.3.  $\square$

If  $S_0$  is an accidental incompressible Seifert surface for  $K$ , by the argument in the proof of Theorem 3.2.3,  $S_1 = \partial(S^3 - \mathring{N}(S_0; S^3))$  is incompressible. Hence  $S_0$  is totally knotted. Thus, we have:

**Proposition 3.2.9.** *An accidental incompressible Seifert surface  $S$  is totally knotted and the knot complement contains a closed incompressible surface of genus  $2g(S)$ .*  $\square$

### 3.2.2 On general 3-manifolds

The accidental Seifert surface constructed above is actually non-minimal genus, as the result of Fenley [7]. Here we remark that a minimal genus Seifert surface for a knot in some 3-manifold can be accidental.

**Proposition 3.2.10.** *There exists a closed hyperbolic Haken 3-manifold  $M$  such that  $M$  contains a hyperbolic knot  $K$  with an accidental Seifert surface of genus one.*

*Proof.* Let  $T$  be a genus one, orientable surface with a connected boundary. Let  $l$  be an essential simple closed curve in  $T$ . Put  $M_0 = T \times I$ ,  $H_+ = \partial T \times I$ , and  $H_- = N(l; T) \times \{1\}$ . By identifying two annuli  $H_+$  and  $H_-$  with some homeomorphism, we obtain an orientable 3-manifold  $M_1$  with  $\partial M_1$  connected, closed, genus two. Using the product structure of  $M_0$ , it can be shown that each component of  $\partial M_0 - (\partial H_+ \cup \partial H_-)$  is incompressible, there is no properly embedded disk  $D$  in  $M_0$  such that each of  $\partial D \cap H_{\pm}$  and  $\partial D \cap (\partial M_0 - \mathring{H}_+ \cup \mathring{H}_-)$  is a single arc, and that there is no essential annulus with boundaries in  $H_+ \cup H_-$ . Thus,  $M_1$  is irreducible,  $\partial$ -irreducible, and atoroidal.

Put  $K = \partial T \times \{1/2\}$ . Notice that the knot  $K$  bounds a genus one Seifert surface, still denoted by  $T$ , with an accidental annulus  $l \times [1/2, 1]$  in  $M_1$ . Let  $V$  be an irreducible,  $\partial$ -irreducible, atoroidal, and anannular 3-manifold such that  $\partial V$  is a genus two closed surface.

We glue  $M_1$  and  $V$  with their boundaries, and get a closed manifold  $M$  which is irreducible, atoroidal, and contains an incompressible surface, say the gluing surface. Thus, this manifold is hyperbolic by Thurston's geometrization theorem (cf. [70]).

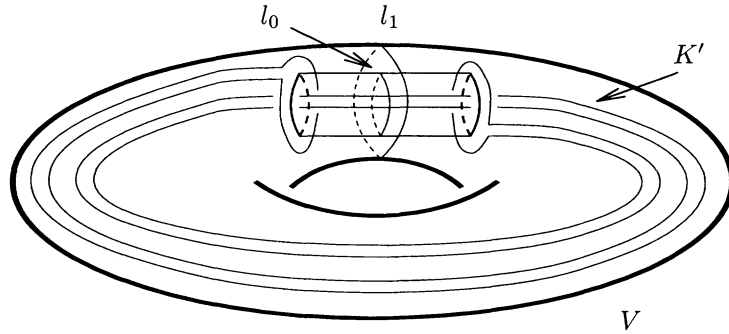

Figure 3.3:

To see the knot  $K$  is hyperbolic, we show that  $E(K)$  is irreducible,  $\partial$ -irreducible, atoroidal, anannular. Using the product structure again, we can show that  $E(K; M_1) = M_1 - \mathring{N}(K; M_1)$  is irreducible,  $\partial$ -irreducible, and atoroidal. Since  $V$  is irreducible,  $\partial$ -irreducible, atoroidal, and anannular, the exterior  $E(K; M) = V \cup_{\partial V = \partial M_1} E(K; M_1)$  is irreducible,  $\partial$ -irreducible, atoroidal and anannular.  $\square$

### 3.3 Satellite knots with accidental Seifert surfaces

#### 3.3.1 Construction

In this section, we prove Theorem 3.2.5 by constructing infinitely many knots in  $S^3$  of distinct types with accidental incompressible Seifert surfaces. Also we construct a closed hyperbolic Haken 3-manifold which contains a hyperbolic knot which bounds an accidental incompressible Seifert surface.

*Proof of Theorem 3.2.5.* Let  $V$  be a solid torus and  $K'$  be the knot in  $V$  as shown in Figure 3.3, and  $S_0$  be the genus one Seifert surface spanned by  $K'$  in  $V$ .

Let  $K_0$  be a composite knot in  $S^3$ , and for any integer  $n > 0$ , let  $A_0, A_1, \dots, A_n$  be mutually parallel essential annuli in  $E(K_0)$  coming from the decomposing sphere of the composite knot  $K_0$ . There exists an annulus  $A$  in  $V$  such that  $\partial A = l_0 \cup l_1$  and  $A \cap S_0 = l_0$  where  $l_0$  is a non-separating curve in  $S_0$  and  $l_1$  is the boundary of a meridian disk of  $V$ . Let  $N$  be a regular neighbourhood of  $\partial(V - \mathring{N}(S_0)) - \partial V$  in  $V - \mathring{N}(S_0)$  which is homeomorphic to a product  $S^* \times I$  where  $S^*$  is a closed surface with  $\chi(S^*) = 2\chi(S_0)$  and  $S^* \times \{1\} \subset \mathring{V}$ . Set  $S_i = S^* \times \{i/n\}$  for  $1 \leq i \leq n$ . After “ $\partial$ -annulus-compressions” along  $A$  (see Figure 3.4), we get surfaces  $S'_n, S'_{n-1}, \dots, S'_0$  from the surface  $S_n, S_{n-1}, \dots, S_0$ . We remark  $K'$  is a non-trivial knot, and each  $S'_i$  is not homeomorphic to an annulus.

**Proposition 3.3.1.** *Each  $S'_i$  is  $\pi_1$ -essential in  $V - K'$ .*



*Proof.* First, we claim that it suffices to show  $S_i$  is incompressible in  $V - K'$ . If  $D$  is a compressing disk for  $S'_i$ , then  $D$  can be modified to a compressing disk for  $S_i$ . Hence, if  $S_i$  is incompressible, then  $S'_i$  is also incompressible. Suppose  $D$  is a  $\partial$ -compressing disk for  $S'_i$  such that  $\partial D = \alpha \cup \beta, \alpha \subset \partial V, \beta \subset S'_i$ . By the construction,  $\partial S'_i$  separates  $\partial V$  into a union of two annuli  $B_0, B_1$ , so  $\alpha$  is an essential arc in, say,  $B_0$ . We identify a regular neighbourhood  $N'$  of  $D$  in the closure of  $V - S'_i$  with  $D \times I$ . Put  $D_i = D \times i$  for  $i = 0, 1$ . Then  $(B_0 - N') \cup D_0 \cup D_1$  forms a disk  $D'$  such that  $\partial D' \subset S'_i$ . If  $S'_i$  is incompressible, then  $\partial D'$  bounds a disk  $E$  in  $S'_i$  on the side not containing  $\partial D$  and the sphere  $D' \cup E$  bounds a 3-ball  $C$  on the side not containing  $D$ . The solid torus  $C \cup N'$  is a  $\partial$ -parallelism for  $S'$ , this is a contradiction and this proves our first claim.

Next, we show that  $S_i$  is incompressible. Since  $S_0$  is a genus one Seifert surface and  $K'$  is non-trivial, it is incompressible. Put  $F_0 = \partial N(S_0; V)$ . Since  $F_0$  is incompressible in  $N(S_0; V) - K'$ , it suffices to show that  $F_0$  is incompressible in  $V - \dot{N}(S_0; V)$ . Let  $D'$  be a meridian disk of  $V$  which contains  $A$  such that  $\partial D' = l_1$  and  $D' - N(S_0; V)$  is a union of annuli  $B, B'$  ( $B' \subset A$ ). Let  $D$  be a compressing disk for  $F_0$ . We assume  $|D \cap (B \cup B')|$  is minimal among all compressing disks. We claim that if  $D$  intersects  $B \cup B'$ , then  $D \cap B$  is a union of essential arcs in  $B$ , and  $D \cap B' = \emptyset$ . If some component is an inessential loop or arc, we can reduce the number  $|D \cap (B \cup B')|$ . If  $\Delta$  be an innermost disk of  $D$  with respect to  $D \cap (B \cup B')$ , then  $\partial \Delta$  is a core of  $B$  or  $B'$ . But there exists a loop  $l$  in  $N(S_0; V)$  such that  $l$  intersects the sphere  $D'' \cup \Delta$  with non-zero algebraic intersection number, where  $D''$  is a disk in  $D'$  bounded by  $\partial \Delta$ . This means that  $D'' \cup \Delta$  does not bound a 3-ball, a contradiction to the irreducibility of  $V$ . If  $\Delta'$  is an outermost disk in  $D$  with  $\partial \Delta' = \alpha' \cup \beta' (\alpha' \subset B)$ , then by the above claim,  $\alpha'$  is an essential arc in  $B$ . If  $F = F_0 - \dot{N}(D'; V)$ , then  $F \cap \beta'$  is a connected arc in  $F$  since  $\beta' \cap (B \cup B') = \emptyset$ . But it is impossible because two points  $\partial(\beta' \cap F)$  lie in distinct component of  $F$ . So,  $D \cap (B \cup B') = \emptyset$ . Now, it is easy to see that  $\partial D$  bounds a disk in  $F$ . This completes the proof.  $\square$

We embed  $V$  in  $S^3$  so that  $V = N(K_0)$  and  $\partial_+ A_0 = \partial_- S'_0, \partial_+ A_i = \partial_+ S'_{i-1} (1 \leq i \leq n), \partial_- A_n = \partial_+ S'_n, \partial_- A_i = \partial_- S'_{i+1}, (n-1 \geq i \geq 0)$ . (see Figure 3.4). We let  $K$  be the image of  $K'$ .

The surface  $S = \cup_{i=0}^n A_i \cup S'_i$  is an orientable Seifert surface for  $K$  of genus  $n+1$ , and has an accidental peripheral (Figure 3.5).

Since  $K_0$  is composite, each annulus  $A_i$  is  $\pi_1$ -essential in  $E(K_0)$ , and by Proposition 3.3.1, each  $S'_i$  is  $\pi_1$ -essential. Hence we can show that the Seifert surface  $S$  is incompressible in  $E(K)$ .

It is not hard to see, because  $S'_i$  is incompressible, that the *wrapping number*  $w_V(K') = 2$  where the wrapping number  $w_V(K')$  is defined to be the geometric intersection number of  $K'$  with a meridian disk in  $V$ . So, by twisting the knot  $K'$  along the loop  $l_1$  in the solid torus  $V$ , one can produce infinitely many knots of distinct types, by [43, Theorem 2.1]. This completes the proof.  $\square$

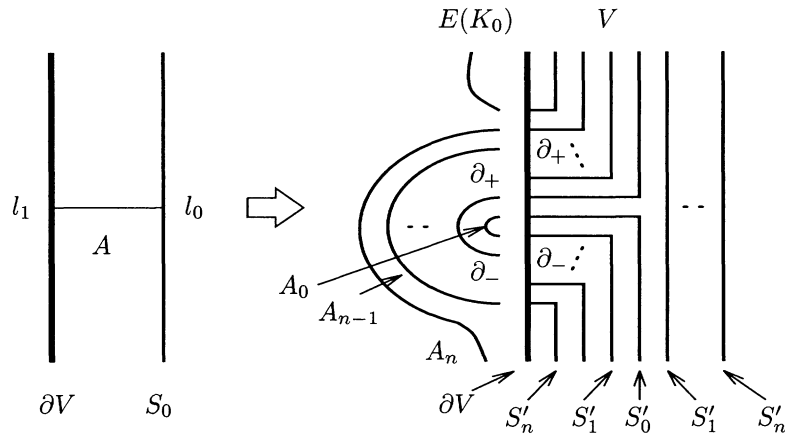

Figure 3.4:

*Remark 3.3.2.* In [49] and [15], genus one knots with arbitrarily high genus Seifert surface are given. In particular, the knot Gustafson([15]) constructed is simple.

### 3.4 Hyperbolic knots with accidental Seifert surfaces

We give a method to construct a hyperbolic knot which bounds an incompressible Seifert surface of arbitrarily high genus with accidental peripherals.

Let  $M$  be a 3-manifold and let  $S$  be a surface properly embedded in  $M$ . An essential loop in  $S$  is called an *accidental peripheral in  $M$*  if it is freely homotopic into  $\partial M$  in  $M$ . A Seifert surface  $F$  bounded by a knot  $K$  is said to have accidental peripherals if  $F \cap E(K)$  has accidental peripherals in  $E(K)$  where  $E(K)$  denotes the exterior of  $K$ . If a Seifert surface has an accidental peripheral, then we say it is *accidental*. If a hyperbolic knot bounds an accidental incompressible Seifert surface, by a result of Thurston [70] and Bonahon [3], it corresponds to a geometrically finite but not quasi-Fuchsian subgroup of  $\text{Im}(\rho : \pi_1(E(K)) \rightarrow \text{Isom}^+(\mathbf{H}^3))$ .

Accidental surfaces have interesting properties in both knot theory and hyperbolic geometry. In [60, Theorem 1.3], we showed if  $K$  bounds an accidental incompressible Seifert surface  $F$ , then  $E(K)$  contains a closed essential surface, indeed  $E(F)$  is  $\partial$ -irreducible, and it is known that the boundary slope of a properly embedded surface with accidental peripherals in the exterior of a knot in  $S^3$  is integral or  $\infty$  [60, Theorem 1.4]. Ichihara-Ozawa ([22] and [24]) gave several properties of accidental closed essential surfaces embedded in knot complements in  $S^3$  and showed in [22] a large class of knots deny the Menasco-Reid conjecture [52], the conjecture that hyperbolic knot complements in  $S^3$  do not contain closed totally geodesic embedded surfaces. In [24], several applications to Dehn surgery on hyperbolic knots were given.

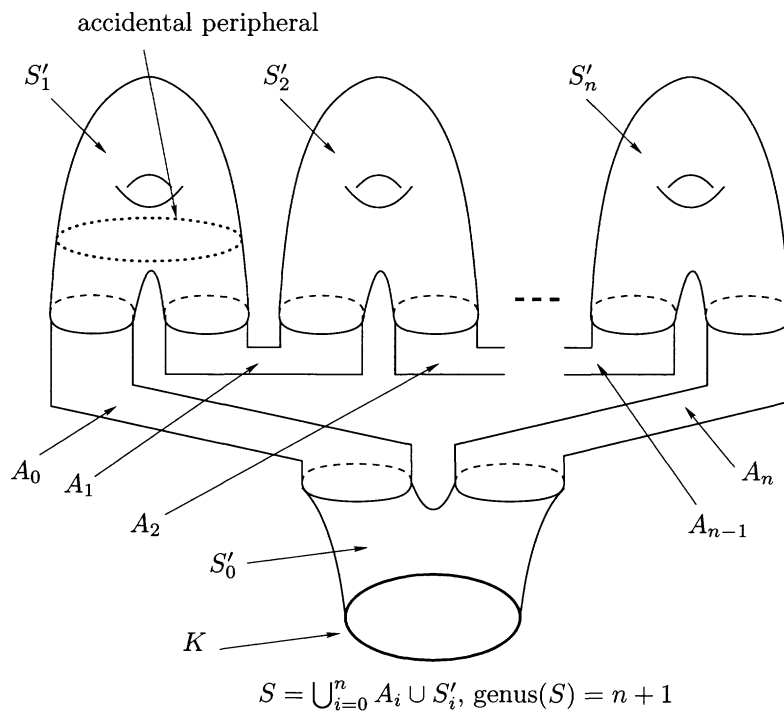

Figure 3.5:

In [7], Fenley showed that any minimal genus Seifert surface spanned by a knot in  $S^3$  contains no accidental peripheral using Gabai's results on taut finite depth foliations [11]. It is known that some hyperbolic 3-manifold contains a hyperbolic knot which bounds a genus one, so it is minimal genus, incompressible accidental Seifert surface [60]. In [60], we studied some property of properly embedded surfaces in knot exteriors with accidental peripherals and constructed satellite knots with infinitely many accidental incompressible Seifert surfaces.

Here we remark that not all hyperbolic knots does not bound accidental incompressible Seifert surfaces. In fact, small knots, fibered knots, not totally knotted knots have no accidental incompressible Seifert surfaces [60, Theorem 1.3]. In this section, we give a method to construct hyperbolic knots in a closed 3-manifold each of which bounds arbitrarily high genus incompressible Seifert surfaces with accidental peripherals. We have:

**Theorem 3.4.1.** *Any orientable closed 3-manifold contains a genus one hyperbolic knot which bounds an incompressible Seifert surface of arbitrarily high genus, with non-separating accidental peripherals.*

The knot illustrated in Figure 3.2 is an example of hyperbolic knot which is constructed by our algorithm.

There are several results on constructing knots with arbitrarily high genus incompressible Seifert surfaces. In [49], Lyon constructed a satellite knot, and in [15], Gustafson gave a simple knot. In [41], Kobayashi constructed free essential Seifert surfaces of arbitrarily high genus for a certain pretzel link to obtain Haken 3-manifolds each of which admits infinitely many non-equivalent strongly irreducible Heegaard splittings.

### 3.4.1 Preliminaries

Let  $M$  be a 3-manifold and  $S$  be a surface in  $M$  properly embedded or contained in  $\partial M$ . A *compression disk* of  $S$  is an embedded disk  $D$  in  $M$  such that  $D \cap S = \partial D$  and  $\partial D$  does not bound a disk in  $S$ . If  $S$  does not admit compression disks and  $S$  is not simply connected, then we say  $S$  is *incompressible in  $M$*  and call  $S$  an *incompressible surface*. We say  $S$  is *essential* if it is incompressible and not  $\partial$ -parallel. We say  $M$  is *irreducible* if each sphere in  $M$  bounds a 3-ball in  $M$ , and  $M$  is  *$\partial$ -irreducible* if  $\partial M$  is incompressible in  $M$ . A 3-manifold which is irreducible and  $\partial$ -irreducible is said to be *atoroidal* (*anannular* resp.) if it does not contain essential torus (annulus resp.). We say  $M$  is *simple* if it is irreducible,  $\partial$ -irreducible, atoroidal and anannular.

### 3.4.2 Proof of Theorem 3.4.1

*Proof of Theorem 3.4.1.* Let  $\mathcal{H} = (M; H_1, H_2)$  be a Heegaard decomposition of any closed 3-manifold  $M$  and let  $g_{\mathcal{H}}$  denote the genus of the Heegaard splitting. We construct a properly

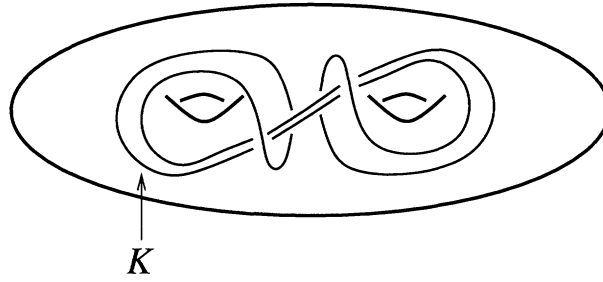

Figure 3.6:

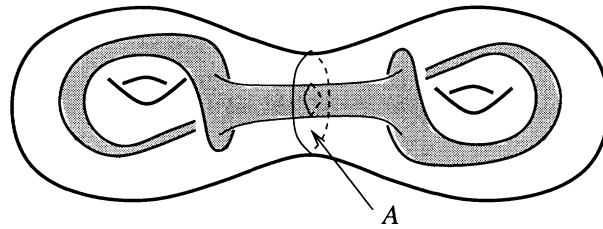

Figure 3.7:

embedded 1-dimensional complexes in  $H_1$  and  $H_2$  as follows. Let  $\Gamma_1$  be a 2-component graph such that one component is an arc and the other is a half-handcuff graph, that is, a connected graph consisting of a loop and a free edge. Let  $\Gamma_2$  be a copy of  $\Gamma_1$ . By Myers' excellent submanifold theory [57, Theorem 1.1], or Kawachi's imitation theory [35, Theorem 1.1], or using Brunnian spatial graphs with hyperbolic exterior with totally geodesic boundary, for example, Suzuki's  $\theta_n$ -curve [67] which is known to have these properties (see Ushijima's work [81] for hyperbolic structures of  $E(\theta_n)$ ) —basic ideas of these three are similar— we can properly embed  $\Gamma_i$  in  $H_i$  so that  $H_i - \mathring{N}(\Gamma_i)$  is simple ( $i = 1, 2$ ). We can choose a gluing map  $f : \partial H_1 \rightarrow \partial H_2$  recovering  $M$  such that  $f(\partial \Gamma_1) = \partial \Gamma_2$  and  $\Gamma = \Gamma_1 \cup_f \Gamma_2$  forms a connected handcuff graph embedded in  $M$ . Since  $E(\Gamma) = M - \mathring{N}(\Gamma)$  is obtained from  $H_1 - \mathring{N}(\Gamma_1)$  and  $H_2 - \mathring{N}(\Gamma_2)$  by gluing them along  $E(\Gamma) \cap \partial H_1 = E(\Gamma) \cap \partial H_2$ , by Lemma 1.2.8, it follows that  $M - \mathring{N}(\Gamma)$  is simple.

In [74, Lemma 5.6], we showed the following.

**Lemma 3.4.2.** *Let  $K$  be the knot illustrated in Figure 3.6 in the handlebody  $V$  of genus two. Then  $V - \mathring{N}(K)$  is irreducible,  $\partial$ -irreducible, atoroidal and there is no essential annulus whose boundaries contained in  $\partial N(K)$ .  $\square$*

We embed  $(V, K)$  in  $M$  along  $N(\Gamma)$  so that  $V \cap \partial H_1$  forms four simple closed curves parallel to the curve indicated in Figure 3.7 in  $\partial V$ , to obtain a genus one knot  $K^*$  in  $M$ . Later we use the same symbol  $V$  for the image of  $V$  of the embedding and regard  $N(\Gamma) = V$ .

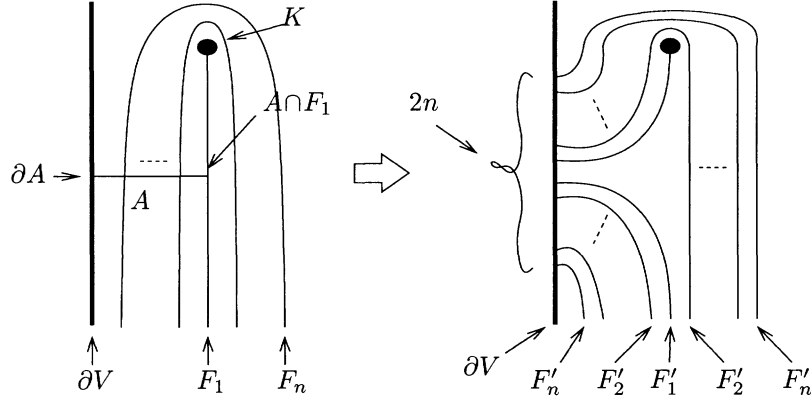

Figure 3.8:

**Proposition 3.4.3.**  $K^*$  is a genus one hyperbolic knot in  $M$ .

*Proof.* The exterior  $E(K) = M - \hat{N}(K)$  is obtained from  $E(\Gamma)$  and  $V - \hat{N}(K)$  by gluing  $\partial E(\Gamma)$  to  $\partial V$ . Hence by Lemma 1.2.7,  $K^*$  is a simple knot in  $M$ . By Thurston's hyperbolization result,  $K^*$  is hyperbolic. Clearly  $K^*$  bounds a genus one Seifert surface in  $V \subset M$ .  $\square$

Let  $F_1$  be the genus one Seifert surface bounded by  $K$  as shown in Figure 3.7.

To complete the proof, we show  $K$  bounds incompressible accidental Seifert surfaces of arbitrarily high genus.

Fix a natural number  $n \geq 2$  arbitrarily.

Let  $F_2, \dots, F_n$  be mutually disjoint  $n - 1$  parallel surfaces in  $V$ , such that each  $F_i$  is parallel to  $\partial N(F_1)$  in  $V$ . Let  $A$  be the annulus indicated in Figure 3.7 such that one of whose boundary components is contained in  $F_1$  and the other is in  $\partial V$ . We may assume that  $A$  and  $F_2 \cup \dots \cup F_n$  are in general position and  $A \cap F_i$  consists of a single circle. Thus we may suppose  $A \cap (F_2 \cup \dots \cup F_n)$  is a disjoint union of essential loops in  $A$ . Performing an "annulus compression" along  $A$  to each  $F_i$  in  $V$  to  $\partial V$ , we obtain mutually disjoint surfaces  $F'_i$ 's as shown in Figure 3.8.

Let  $S_1, \dots, S_n$  be mutually parallel properly embedded surface in  $E(\Gamma)$  such that each  $S_i$  is parallel to  $E(\Gamma) \cap (H_1 \cap H_2)$ . Without loss of generality, we may assume  $S_1$  is nearest to  $H_1$ . It is noticed that each  $S_i$  has three boundary components. Let  $c_i$  denote a component of  $\partial S_i$  which bounds a genus one surface  $U_i$  in  $\partial V$  with  $S_i \cap U_i = c_i$ . Though there are two choice of  $c_i$  for each  $S_i$ , we choose  $c_1$  for  $S_1$  on the side of  $H_1$ , and  $c_2, \dots, c_n$  for  $S_2, \dots, S_n$  on the side  $H_2$ . Put  $S'_i = S_i \cup U_i$ . By pushing  $S'_i$ 's slightly into  $E(\Gamma)$ , we put them mutually disjoint as shown in Figure 3.9. It is remarked that  $\partial S'_i$  consists of two components and  $\sum_{i=1}^n |\partial S'_i| = 2n$ .

Sewing  $\bigcup_{i=1}^n S'_i$  and  $\bigcup_{i=1}^n F'_i$  in  $M$ , we obtain a surface  $S_n^*$  with  $\partial S_n^* = K^*$ .

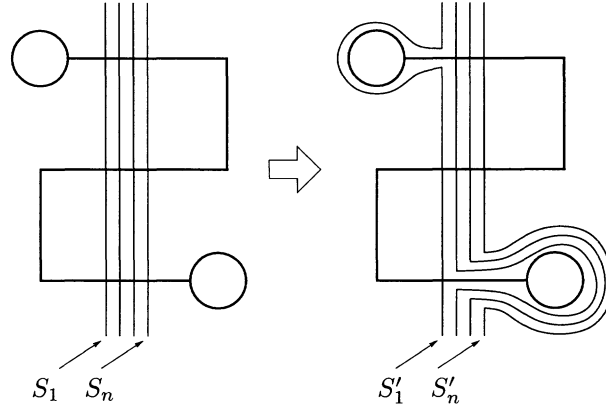

Figure 3.9:

**Proposition 3.4.4.**  $S_n^*$  is orientable and connected.

*Proof.* It is noticed that each  $S'_i$  has two boundary components. It is observed that  $S'_1$  joins  $F'_n$  to  $F'_{n-1}$ ,  $S'_2$  joins  $F'_{n-2}$  to  $F'_n$ ,  $S'_i$  joins  $F'_{n-i}$  to  $F'_{n-i-2}$  for  $i = 2, \dots, [n/2]$ , thus we can see that  $S_n^*$  is orientable and connected successively.  $\square$

**Proposition 3.4.5.**  $S_n^*$  is a Seifert surface for  $K^*$  of genus  $g_{\mathcal{H}} + 2n$ .

*Proof.* By the construction of  $S'_i$ , we have  $\chi(S'_i) = -2g_{\mathcal{H}} - 2$ . On the other hand, it follows that  $\chi(F'_1) = -1$  and  $\chi(F'_j) = -2$  ( $j > 1$ ). Thus we have  $\chi(S_n^*) = (-2g_{\mathcal{H}} - 2)n - 1 - 2(n-1) = -2g_{\mathcal{H}}n - 4n + 1$  and  $g(S_n^*) = g_{\mathcal{H}} + 2n$ .  $\square$

Now our goal is to show  $S_n^*$  is incompressible. To show this, it is sufficient to show  $E(S_n^*)$  is  $\partial$ -irreducible.

It is observed that in  $E(S_n^*)$ , there are seven annuli decomposing  $E(S_n^*)$  into five components  $M_1, M_2, B, P$  and  $C$  (cf. Figure 3.10 for  $n = 5$ , the circle drawn with dashed curve corresponds to  $\partial V$ ), where  $M_i$  is homeomorphic to  $H_i - \dot{N}(\Gamma_i)$ ,  $B$  is a solid torus,  $P$  is an  $I$ -bundle over a surface with seven boundary components and  $C$  is a 3-manifold obtained as follows. Let  $T_1$  and  $T_2$  be two genus one surfaces such that each of them has a connected boundary. Let  $A_1$  and  $A_2$  be annuli in  $T_1$  and  $T_2$  with  $T_i - A_i$  connected for  $i = 1, 2$ . Then  $C$  is obtained from two product handlebodies  $T_1 \times I$  and  $T_2 \times I$  by gluing  $A_1 \times \{0\}$  and  $A_2 \times \{0\}$  together, and it follows that  $P \cap C = \partial T_1 \times I \cup \partial T_2 \times I$ . This can be seen as follows: It is noticed that  $C$  comes from the region between  $S'_1$  and  $S'_2$  in Figure 3.9. Let  $X$  be the 3-manifold illustrated in Figure 3.11 and let  $A_a$  and  $A_b$  be essential annuli in  $X$  as shown in the figure. By the construction of  $S_n^*$ ,  $C$  is homeomorphic to  $X - \dot{N}(A_a)$ . Furthermore,  $X' = X - \dot{N}(A_b)$  is a product and  $X'' = X' - \dot{N}(A_a)$  is homeomorphic to  $(T_1 \cup T_2) \times I$ .

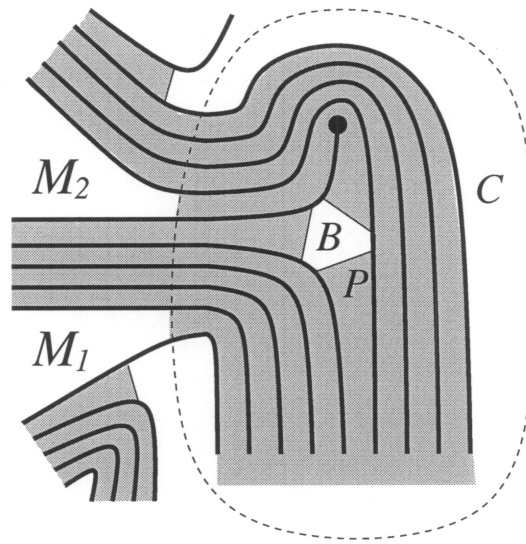

Figure 3.10:

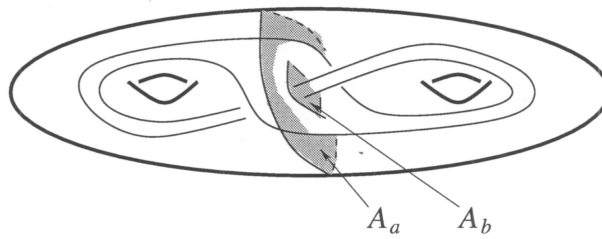

Figure 3.11:



We put  $C_0 = T_1 \times I \cup T_2 \times I$ . Notice that  $C_0$  is homeomorphic to  $X''$ . Gluing  $M_1$ ,  $M_2$ ,  $B$ ,  $P$  and  $C_0$  along the corresponding 14 annuli, we obtain a manifold  $M_0$ . To adapt Lemma 1.2.6 for them to show  $M_0$  is  $\partial$ -irreducible, we will check the gluing condition for each  $M_1$ ,  $M_2$ ,  $B$ ,  $P$  and  $C_0$ . It is clear that each of them is irreducible. Since  $M_i$  is simple, it is  $\partial$ -irreducible and since the core of the annulus  $M_i \cap P$  is non-separating in  $\partial M_i$ ,  $M_i \cap P$  is incompressible in  $M_i$  and  $\partial M_i - (M_i \cap P)$  is also incompressible. The condition for  $B$  is clearly satisfied since it is a solid torus and since  $B \cap P$  consists of three longitudinal annuli. Because  $P$  is an  $I$ -bundle and the corresponding  $\partial I$ -bundle is incompressible in  $P$ , and because  $\partial P$  is separated by the remainder annuli  $P \cap (M_1 \cup M_2 \cup B \cup C)$ , each  $\partial$ -reducing disk has intersection with the boundary of the  $\partial I$ -bundle in more than or equal to four points. Similarly, the condition for  $C_0$  is valid since each component of  $C_0$  is an  $I$ -bundle. Now by Lemma 1.2.6,  $M_0$  is irreducible and  $\partial$ -irreducible.

Since  $A_i$  is non-separating in  $T_i$  and since  $M_0$  is  $\partial$ -irreducible,  $A_i$  is incompressible in  $M_0$  and  $\partial M_0 - (A_1 \cup A_2)$  is incompressible. Notice that  $E(S_n^*)$  is obtained from  $M_0$  by gluing  $A_1$  and  $A_2$  together,  $E(S_n^*)$  is  $\partial$ -irreducible by Lemma 1.2.6.  $\square$

The knot illustrated in Figure 3.2 is a hyperbolic knot constructed by our algorithm. The embedding of the handcuff graph is based on the true lover's tangle which is known to have simple exterior [56, Proposition 4.1]. The corresponding genus zero Heegaard surface of  $S^3$  is viewed from a horizontal line intersecting with the knot in six points.

### 3.5 Excellent Seifert surfaces and applications to accidental surfaces

Let  $S$  be a Seifert surface for a knot in a 3-manifold. We say  $S$  is *excellent* if the exterior  $E(S)$  is irreducible,  $\partial$ -irreducible, atoroidal and anannular. In this section, we give some properties of knots with excellent Seifert surfaces and a method to construct a simple knot which bounds excellent non-orientable Seifert surfaces with distinct boundary slopes.

Let  $X$  be a 3-manifold with  $\partial X$  a union of some tori. An isotopy class of a simple closed curve  $\gamma$  in  $\partial X$  is called a *boundary slope* if there exists an incompressible and  $\partial$ -incompressible surface  $S$  properly embedded in  $X$  such that  $\gamma$  is isotopic to a component of  $\partial F$  in  $\partial X$ . If  $X$  is a knot exterior in some 3-manifold and the knot bounds an orientable Seifert surface, then isotopy classes of simple closed curves in  $\partial X$  is represented by a rational number and  $\infty$ , where 0 represents the boundary slope of orientable Seifert surfaces and  $\infty$  means the meridional slope.

In [18], Hatcher showed that for each component  $T$  of  $\partial X$ , the number of slopes of incompressible and  $\partial$ -incompressible surfaces such that all boundary components are contained in  $T$  is finite, using branched surface theory developed by Floyd and Oertel [8]. As a consequence, it can be shown that all but finitely many Dehn surgery along a small knot,

that is, a knot without closed incompressible non- $\partial$ -parallel surfaces in the exterior, produce non-Haken 3-manifolds.

In [19], Hatcher and Oertel showed that each rational number is realized as a boundary slope for some Montesinos knot, and gave an algorithm to calculate boundary slopes of Montesinos knots.

In [22], Ichihara and Ozawa studied *strongly essential surfaces* in knot exteriors in  $S^3$ . Here a properly embedded surface  $S$  in the knot exterior  $E(K)$  is said to be *strongly essential* if it is incompressible,  $\partial$ -incompressible, and some component  $E(K) - \mathring{N}(S)$  is  $\partial$ -irreducible. In [22], it was shown that the number of components of strongly essential surfaces is at most two, the boundary slope of a strongly essential surface is integral or  $\infty$ , and some applications to Dehn surgery was given.

Here we give a method to construct a knot admitting strongly essential surfaces, in fact, excellent Seifert surfaces. For a knot  $K$  in a 3-manifold  $X$ , we call a connected surface  $S$ , possibly non-orientable, embedded in  $X$  such that  $\partial S = S \cap K = K$  with boundary slope integral *Seifert surface for  $K$* . For a homological reason, it is noticed that the boundary slope of any Seifert surface is even. A subset  $\Sigma \subset X$  is *totally knotted* if the exterior  $E(\Sigma) = X - \mathring{N}(\Sigma)$  is irreducible and  $\partial$ -irreducible. We denote the boundary slope of a properly embedded surface  $S$  by  $\gamma(S)$ . A Seifert surface  $S$  for a knot  $K$  in  $X$  is said to be *totally knotted* (*excellent* resp.) if  $E(S) = E(K) - \mathring{N}(S)$  is irreducible and  $\partial$ -irreducible (irreducible,  $\partial$ -irreducible, atoroidal, and anannular resp.). Here we remark that some fixed knot can bound infinitely many totally knotted Seifert surfaces [60, Theorem 1.5], up to isotopy, but it can be shown by [73, Theorem 1.1] the number of isotopy classes of excellent Seifert surfaces for a fixed knot is finite. Furthermore, it is remarked that only hyperbolic knots bound excellent Seifert surfaces (Lemma 3.5.3), and if  $K$  bounds an excellent Seifert surface, then any finite fold regular branched covering space along  $K$  is hyperbolic Haken (Lemma 3.5.4).

Our aim in this section is to show the following.

**Theorem 3.5.1.** *For any finite set of even integers  $\{a_1, \dots, a_n\}$ , there exists a simple knot in any closed 3-manifold which bounds excellent non-orientable Seifert surfaces  $F_1, \dots, F_n$  such that  $\gamma(F_i) = a_i$ .*

In fact, strongly essential surfaces produces essential closed surfaces in the knot complement with *accidental peripherals* (see [22] and § 3.5.3). As an application of Theorem 3.5.1, we construct a counterexample to a conjecture on the uniqueness of integral *accidental slopes* of closed essential surfaces in knot complements [22, Conjecture 3.2], which was inspired by [22, Theorem 3.1] and was expected to be unique in [22].

**Theorem 3.5.2.** *For any finite set of even integers  $\{a_1, \dots, a_n\}$ , there exists a simple knot in any closed 3-manifold such that each  $a_i$  is an accidental slope of some closed essential accidental surface in the complement.*

The knot illustrated in Figure 3.1 is a knot constructed by a method similar to our construction given in §3.5.2 but slight differ— which produces smaller genus Seifert surfaces than the original construction in §3.5.2) but does not assure the knot is simple— which bounds non-orientable Seifert surfaces  $F_1$  and  $F_2$  both of them are totally knotted such that  $|\gamma(F_1) - \gamma(F_2)| = 2$ ,  $\chi(F_1) = -3$ ,  $\chi(F_2) = -2$  and the complement contains two accidental surfaces  $S_1$  and  $S_2$  with integral accidental slopes differed by two such that  $\chi(S_1) = -6$  and  $\chi(S_2) = -4$ .

### 3.5.1 Excellent Seifert surfaces

**Lemma 3.5.3.** *Let  $K$  be a knot with an excellent Seifert surface  $S$ . Then  $K$  is simple.*

*Proof.* By splitting along  $\partial N(S)$ , the knot exterior  $E(K)$  is decomposed into two 3-manifolds such that one of them is  $E(F)$  and the other is  $N(F) - \mathring{N}(K)$ . Since  $F$  is excellent,  $E(F)$  is simple. Considering the characteristic Seifert pair of  $(N(F) - \mathring{N}(K), \partial(N(F) - \mathring{N}(K)))$  which consists of an  $S^1 \times S^1 \times I$  and an  $I$ -bundle over a surface with connected boundary, it can be shown that  $N(F) - \mathring{N}(K)$  is irreducible,  $\partial$ -irreducible, atoroidal, and for any essential annulus  $A$  in  $N(F) - \mathring{N}(K)$ ,  $\partial A$  is not contained in  $\partial N(K)$ . Thus, we can apply Lemma 1.2.2 to show that  $E(K)$  is simple.  $\square$

**Lemma 3.5.4.** *Let  $K$  be a knot with an excellent Seifert surface  $S$  in a 3-manifold  $M$ . Then any finite fold branched covering space of  $M$  along  $K$  such that each degree of upstairs branching sets is greater than one is simple Haken.*

*Proof.* Let  $p : M' \rightarrow M$  be such a finite fold branched covering along  $K$ . By the Torus-Annulus Theorem ([28]), it can be seen that each component of  $p^{-1}(E(S))$  is simple. By the condition on the branched covering, each component  $H$  of  $p^{-1}(N(S) - N(K))$  forms a *book of  $I$ -bundles* (see [73, §4] for definition) with each sheet negative Euler characteristic. By [73, Lemma 4.1],  $H$  is irreducible,  $\partial$ -irreducible and atoroidal. Thus by Lemma 1.2.2,  $M'$  is simple. Now it clear that each component of  $p^{-1}(\partial N(S))$  is incompressible in  $M'$ . Thus,  $M'$  is simple Haken.  $\square$

We say a Seifert surface  $S$  for a knot  $K$  is *free* if  $E(S)$  is a handlebody.

**Lemma 3.5.5.** *Any non-trivial knot with a free Seifert surface of genus one does not bound excellent Seifert surfaces.*

*Proof.* Suppose there exists a non-trivial knot  $K$  in a 3-manifold  $M$  which bounds a genus one free Seifert surface  $F$  and an excellent Seifert surface  $S$ . Let  $p : M' \rightarrow M$  be a 2-fold covering space along  $K$ . Clearly  $M'$  is obtained from two copies of  $E(F)$ , which is a genus two handlebody, by gluing their boundaries together and  $M'$  is a closed 3-manifold of Heegaard genus at most two. On the other hand,  $M'$  is obtained from two copies of  $E(S)$ , thus  $M'$  contains a closed separating *acylindrical surface*, that is, an incompressible surface

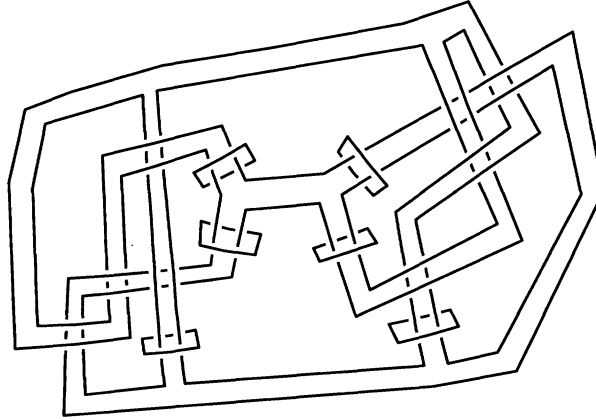

Figure 3.12:

without essential annuli in the cutting result. However it is known that a closed 3-manifold of Heegaard genus at most two does not contain separating acylindrical surface [72, Theorem 1.10]. This completes the proof.  $\square$

It is known that some knot does not bound free incompressible Seifert surfaces [50], and some knot does not bound totally knotted Seifert surfaces, fibered knots for example. On the other hand, Lyon [51] constructed a simple knot  $K_L$  in  $S^3$  which bounds a genus one free Seifert surface  $F_L$  and a genus one totally knotted Seifert surface  $S_L$ . By Lemma 3.5.5,  $S_L$  is not excellent. Though it seems that there exists a simple knot which bounds a free incompressible Seifert surfaces and an excellent Seifert surface. Using J. Week's computer program SNAPPEA, the author have confirmed that a knot obtained from the link illustrated in Figure 3.12 by twisting along six trivial components suitably bounds a free incompressible Seifert surface of arbitrarily high genus and an excellent Seifert surface of genus two.

### 3.5.2 Construction

*Proof of Theorem 3.5.1.* Put  $m = \max\{(\max\{a_1, \dots, a_n\} - \min\{a_1, \dots, a_n\})/2, 1\}$ .

Let  $(B, \tau = t_1 \cup t_2 \cup t_3)$  be a simple 3-string tangle. We can construct such a tangle by Lemma 1.2.9. Let  $D_1 \cup D_2 \cup D_3$  be disjoint union of disks in  $\partial B$  such that  $\partial t_i \subset D_i$ , and let  $p_1 \cup p_2$  be two points in  $\partial B - (D_1 \cup D_2 \cup D_3)$ . We call the 4-tuple  $(B, \tau, D_1 \cup D_2 \cup D_3, p_1 \cup p_2)$  a *node*.

We embed  $m$  copies  $B^{(1)}, \dots, B^{(m)}$  ( $B^{(i)} = (B^{(i)}, \tau^{(i)}, D_1^{(i)} \cup D_2^{(i)} \cup D_3^{(i)}, p_1^{(i)} \cup p_2^{(i)})$ ) of the node in the ambient manifold  $M$  mutually disjoint, and connect  $8m$  points  $\bigcup \partial \tau^{(i)} \cup p_1^{(i)} \cup p_2^{(i)}$  with  $7m$  arcs  $\sigma = s_1 \cup \dots \cup s_{7m}$  in the outside of nodes so that  $\bigcup \tau^{(i)} \cup \sigma$  is connected

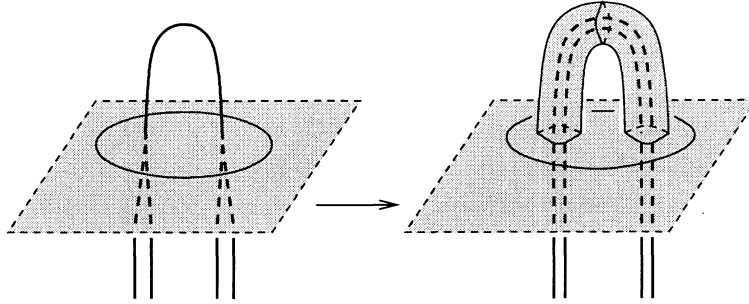

Figure 3.13:  $\Sigma \rightarrow \Sigma'$  (tubing-splitting)

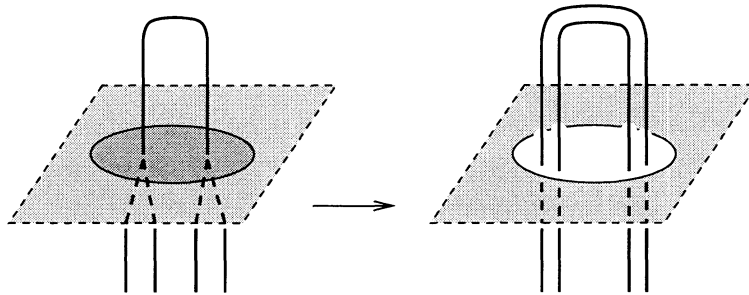

Figure 3.14:  $\Sigma' \rightarrow \Sigma''$  (removing-splitting)

and it forms a graph with  $p_j^{(i)}$  free vertex for each  $i, j$  and such that each point of  $\partial\tau$  is a vertex of valence 3. By Lemma 1.2.9, we can choose  $\sigma$  so that for the 2-complex  $\Sigma = \bigcup \tau^{(i)} \cup \bigcup \partial B^{(j)} \cup \sigma$ ,  $E(\Sigma)$  is simple.

We let  $\Sigma'$  denote the polyhedron obtained from  $\Sigma$  by tubing along some components  $\tau_T$  of  $\tau^{(i)}$ 's inside the node and splitting strings as shown in Figure 3.13. We let  $D_T$  be the union of disks of  $\bigcup D^{(i)}$  each of which contains the boundaries of  $\tau_T$  and put  $D_R = \bigcup D^{(i)} - D_T$  and put  $P = D_R - \partial\sigma$ . Let  $\Sigma''$  be a polyhedron obtain from  $\Sigma'$  by removing  $P$  and splitting strings in the node as shown in Figure 3.14. We call components of  $D_R$  and  $D_T$  *removing disks* and *tubing disks* respectively. Later,  $N(\Sigma'')$  will match a regular neighborhood of a desired excellent Seifert surface.

**Lemma 3.5.6.**  $E(\Sigma')$  is simple.

*Proof.* It is noticed that  $E(\Sigma')$  is obtained from  $E(\Sigma)$  by gluing certain pants  $P'$  in  $\partial E(\Sigma)$  together. To adapt Lemma 1.2.2, we show that  $\partial E(\Sigma) - \partial P'$  satisfy the condition in Lemma 1.2.2. By the construction of  $\Sigma$ , each component of  $\partial P'$  is non-separating in  $\partial E(\Sigma)$  thus it is not contractible in  $\partial E(\Sigma)$ . Suppose  $\partial E(\Sigma) - \partial P'$  is compressible and let  $R$  be a compression disk. Since  $E(\Sigma)$  is simple,  $\partial R$  bounds a disk  $R'$  in  $\partial E(\Sigma)$  containing some

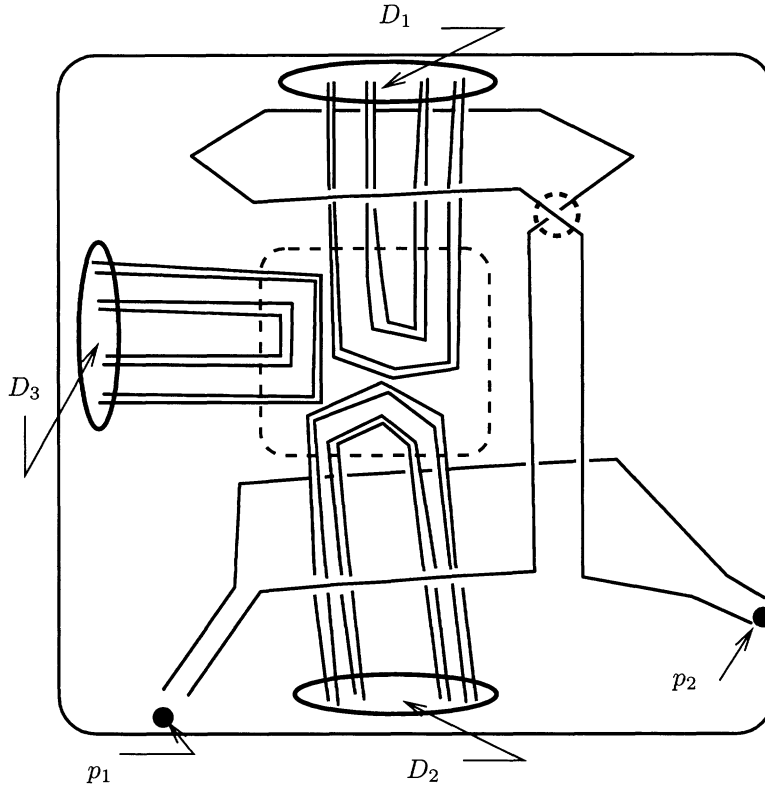

Figure 3.15:

component of  $\partial P'$ . However, in this case the innermost one is contractible in  $\partial E(\Sigma)$ . This is a contradiction. Now since  $E(\Sigma)$  is simple, we can apply Lemma 1.2.2 to show  $E(\Sigma')$  is simple.  $\square$

**Lemma 3.5.7.**  $E(\Sigma'')$  is simple.

*Proof.* Let  $\Sigma^T$  be the polyhedron obtained from  $\Sigma$  by performing the tubing-splitting operation as shown in Figure 3.13 along all components of  $\bigcup D^{(i)}$ . By Lemma 3.5.6,  $E(\Sigma^T)$  is simple. It is noticed that  $E(\Sigma'')$  is obtained from  $E(\Sigma^T)$  by gluing  $\partial E(\Sigma^T)$  along once-punctured tori  $T$  corresponding to  $P$ . To apply Lemma 1.2.2, it is sufficient to show that  $\partial E(\Sigma^T) - \partial T$  is incompressible since  $E(\Sigma^T)$  is simple. Suppose there exists a compression disk  $R$  of  $\partial E(\Sigma^T) - \partial T$ . Since  $E(\Sigma^T)$  is simple,  $\partial R$  bounds a disk  $R'$  in  $\partial E(\Sigma^T)$ . By the construction of  $\Sigma^T$ , it is easy to see that each component of  $\partial T$  is not contractible in  $\partial E(\Sigma^T)$ . Thus,  $R$  does not contain any component of  $\partial T$  and this implies that  $\partial E(\Sigma^T) - \partial T$  is incompressible in  $E(\Sigma^T)$ . Now by Lemma 1.2.2,  $E(\Sigma'')$  is simple.  $\square$

Now it is noticed that  $N(\Sigma'')$  is homeomorphic to a handlebody.

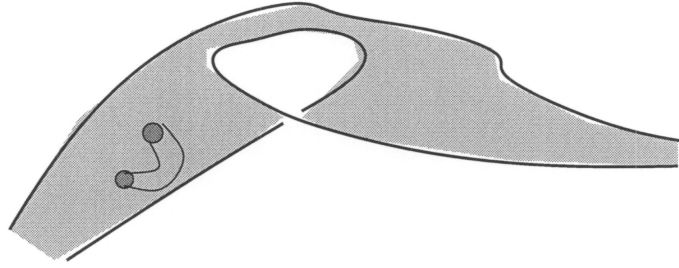

Figure 3.16:  $D_R = D_1 \cup D_2$

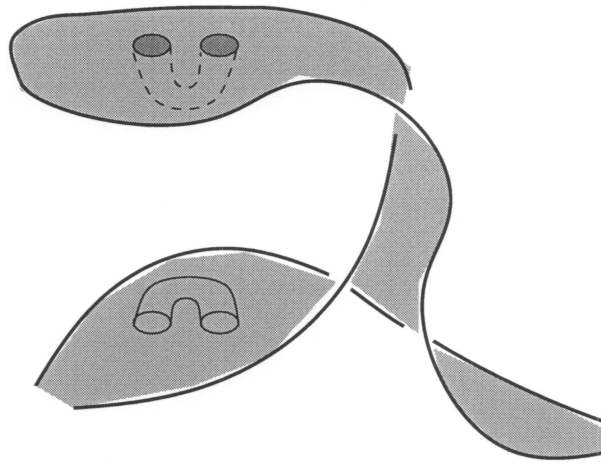

Figure 3.17:  $D_R = D_3$

By embedding an oriented simple closed curve in  $N(\Sigma)$ , we construct a knot  $K$  such that each of  $K \cap N(\tau^{(i)})$  and  $K \cap N(\sigma^{(i)})$  forms an incoherently oriented bands and  $K$  is viewed in each node as illustrated in Figure 3.15. There are two forms for surfaces in each node (see Figures 3.16 and 3.17, six bands are not drawn in those pictures, and corresponding removing disks are indicated), one of them is a Möbius band with a single and six bands, the other is a disk with two knotted handles and six bands, with boundary slopes differed by two. Thus  $K$  bounds  $2^m$  non-orientable Seifert surfaces, and the difference of boundary slopes is contributed by the crossing indicated by the dotted circle. In each node, we choose the crossing indicated by the dotted circle in Figure 3.15 so that the number of all positive crossings coincide  $\max\{a_i, 0\}$ . Thus, by twisting a band coming from  $\sigma$  suitably, we can construct a non-orientable Seifert surface of boundary slope arbitrary even number  $\gamma$  with  $\max\{a_i\} \leq \gamma \leq \min\{a_i\}$  for a fixed knot  $K$ .

It is noticed that for each Seifert surface  $F$  bounded by  $K$  as above,  $E(F)$  is homeomor-

phic to  $E(\Sigma'')$  for some removing disks. Thus by Lemma 3.5.7,  $F$  is excellent. Hence by Lemma 3.5.3,  $K$  is simple. This completes the proof.  $\square$

### 3.5.3 Accidental surfaces

Let  $K$  be a knot in  $S^3$ . An essential closed surface  $S$  in  $E(K)$  is said to be *accidental* if there is an embedded annulus  $A$  with  $\partial A = l' \cup l$  such that  $A \cap S = l'$  and  $A \cap \partial E(K) = l$ . It is known that the slope determined by  $l$  is independent of the choice of  $A$  [22, Theorems 1.2]. Hence such a slope is called an *accidental slope* for  $S$ . Furthermore it is known that any accidental slope is integral or  $\infty$  [22, Lemma 2.5.3] and an example of a knot admitting accidental surfaces of accidental slopes 0 and  $\infty$  is given in [22, Figure 1].

On the other hand, mutually disjoint accidental surfaces have the same accidental slopes [22, Theorem 3.1]. In [24], Ichihara and Ozawa estimated an upper bound on the difference of integral accidental slopes as follows:

**Theorem 3.5.8** (cf. [24, Theorem 3.2]). *Let  $S_1$  and  $S_2$  be accidental surfaces with integral accidental slopes  $s_1$  and  $s_2$  in  $E(K)$ . Then  $|s_1 - s_2| \leq \min\{-\chi(S_1), -\chi(S_2)\}$ .  $\square$*

The knot illustrated in Figure 3.1 is a knot constructed by a similar method to one explained in §3.5.2 but slight differ, concerning only  $\partial$ -irreducibilities of each objects, which contains two accidental surfaces  $S_1$  and  $S_2$  such that  $|s_1 - s_2| = 2$ ,  $\chi(S_1) = -6$  and  $\chi(S_2) = -4$ , thus it is a counterexample to [22, Conjecture 3.2]. The best-possibility of Theorem 3.5.8 seems to be open yet.

*Proof of Theorem 3.5.2.* Let  $K$  be a simple knot in a 3-manifold  $M$  obtained in Theorem 3.5.1 for given  $\{a_i\}$ . Since each Seifert surface  $F_i$  for  $K$  is excellent, the closed surface  $S_i = \partial N(F_i)$  is incompressible in  $M - K$  and has an accidental annulus disjoint from  $F_i$ . Thus the accidental slope of  $S_i$  coincides  $\gamma(F_i) = a_i$ .  $\square$



## Chapter 4

# Experiments

In this chapter, we give experimental results on computer. Most calculations are done with “SNAPPEA Kernel” (linked from [84]), and we are very grateful to J. Weeks, the author of SNAPPEA, for making this possible.

### 4.1 Digging against hyperbolic 3-manifolds of small volumes in several situations

It is known that the set of volumes of hyperbolic 3-manifolds forms a well-ordered set [70]. In this chapter, we give an experimental result in searching hyperbolic 3-manifolds of small volumes in the following classes: (A) hyperbolic knots with closed essential surfaces in their complements, (B) hyperbolic knots with closed acylindrical surfaces in their complements, (C) hyperbolic knots in a handlebody. Known results and conjectures in some other classes are indicated in Figure 4.1, where “TGB” means “with totally geodesic boundary”.

The exterior of the graph  $\Gamma$  illustrated in Figure 4.4(A) is known to be one of the smallest hyperbolic 3-manifolds with totally geodesic boundary [42]. Actually they are

(0)	closed	0.9427...	
(1)	1-cusped	2.0298...	[4]
(2)	2-cusped	3.6638...	see [88] for some approaches
(3)	3-cusped	5.3334...	Figure 4.2
(4)	TGB	6.4519...	Figure 4.3 [42]
(5)	1-cusped, TGB	7.7976...	Figure 4.7

Figure 4.1:

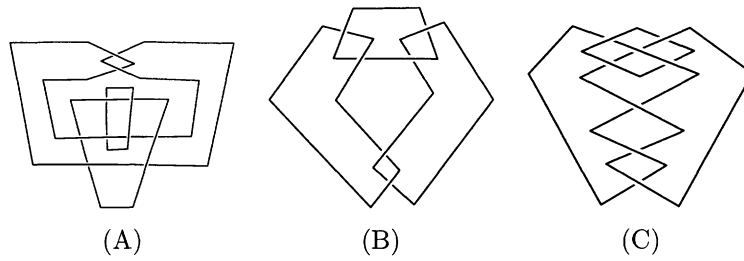

Figure 4.2:

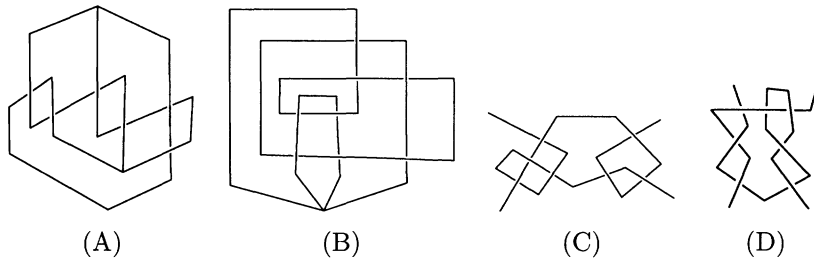

Figure 4.3:

homeomorphic, and the double is obtained by 0-surgery on both components of the link illustrated in Figure 4.4(C). It can be seen that  $E(\Gamma)$  is homeomorphic to the exterior of the graph illustrated in Figure 4.3(B).

The knot illustrated in Figure 4.5(B) is a hyperbolic knot with a closed incompressible surface of genus two in its complement, which was found by Eudave-Muñoz [6].

The knot illustrated in Figure 4.6(A) is a hyperbolic knot found by Adams-Reid [1] as the first explicit example of a knot with acylindrical surface in its complement. It admits a closed acylindrical surface of genus two. The knot illustrated in Figure 4.6(B) which was found here also admits a closed acylindrical surface of genus two. The volume is approximately 20.3455....

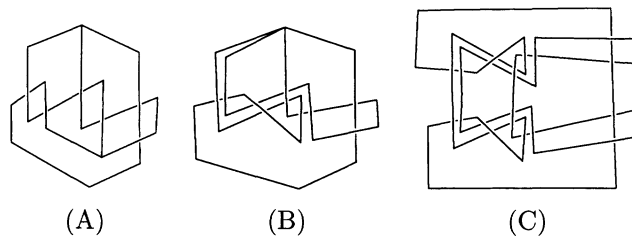

Figure 4.4:

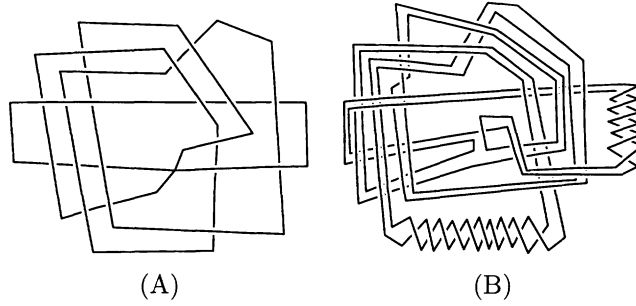

Figure 4.5:

According to Thurston [70], the followings hold.

**Lemma 4.1.1.** *Let  $M$  be a cusped hyperbolic 3-manifold. If  $M'$  is a hyperbolic 3-manifold obtained from  $M$  by filling a cusp of  $M$ , then  $\text{vol}(M) > \text{vol}(M')$ .  $\square$*

**Lemma 4.1.2.** *Let  $M$  be a 3-manifold such that the interior admits a complete hyperbolic structure of finite volume. For a toral component of  $\partial M$ , there are only finitely many slopes giving a non-hyperbolic manifold by Dehn-filling.  $\square$*

Let  $K$  be a knot in a handlebody  $V$ . If  $K$  is hyperbolic, then we have  $\text{vol}(V - K) > 6.4519\dots$  by Lemmas 4.1.1, 4.1.2 and [42]. The knot in 4.7(B) is an example of hyperbolic knots in a handlebody of genus two. Its volume is approximately 7.7976....

From the link in  $S^3$  as shown in Figure 4.7(A), we obtain a link  $L$  in  $M = S^2 \times S^1 \# S^2 \times S^1$  by performing 0-surgery on two vertical components, which is the double of the complement of  $K$  in the handlebody of genus two. We can calculate the volume of  $V - K$  from  $\text{vol}(M - L)$  by dividing by 2.

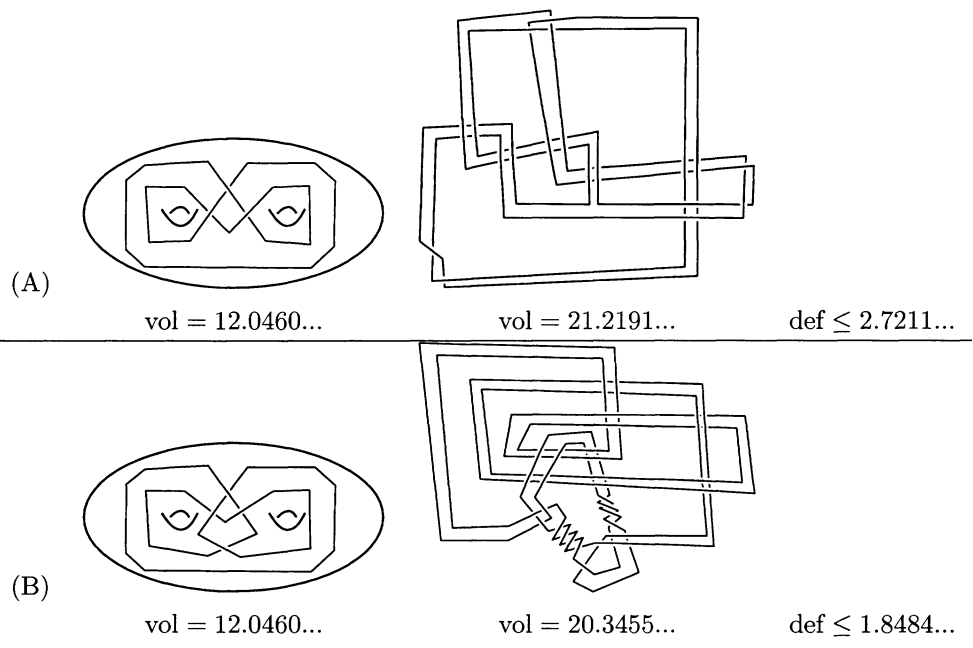

Figure 4.6:

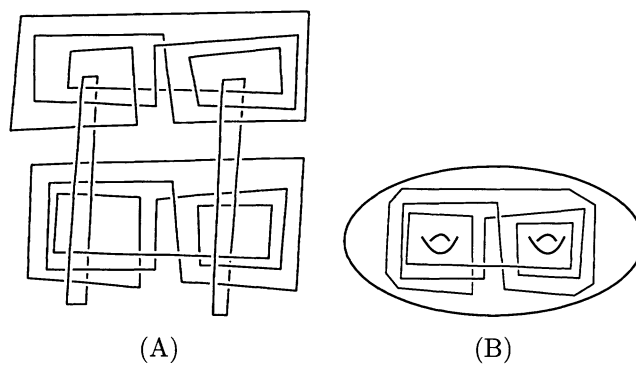

Figure 4.7:

## Chapter 5

# Applications of the Handle Addition Lemma

### 5.1 A sufficient condition for spatial graphs to be totally knotted

A 3-manifold  $M$  is said to be  $\partial$ -irreducible if  $\partial M$  is *incompressible* in  $M$ , namely, for any disk  $D$  properly embedded in  $M$ ,  $\partial D$  bounds a disk in  $\partial M$ . Otherwise  $M$  is  $\partial$ -reducible. See [28] for basic terminologies in the 3-dimensional topology which are not stated here. In [16], Haken constructed an algorithm to detect if an irreducible 3-manifold is  $\partial$ -irreducible or not. See also Jaco-Oretel [29] for a survey. The algorithm is valid for all irreducible 3-manifolds with a handle decomposition, but it is not adapted for an execution by hand. Here, we give a sufficient condition for a certain 3-manifold with non-empty connected boundary to be  $\partial$ -irreducible, and consider some properties of minimally knotted spatial graphs in  $S^3$ . Indeed our sufficient condition is adaptable for not all irreducible 3-manifolds, but is much easier to check than Haken's algorithm.

In §5.1.1, we introduce some concept for curves in the boundary of a 3-manifold to state a sufficient condition to be  $\partial$ -irreducible as follows (see §5.1.1 for definitions and notation).

**Theorem 5.1.1.** *Let  $M$  be a 3-manifold. If there exists a disjoint union of simple closed curves in  $\partial M$  such that  $(M, J)$  is almost trivial, then  $M$  is  $\partial$ -irreducible.*

In fact, Theorem 5.1.1 has various applications to spatial graphs as will be described in §5.1.2. A spatial graph means an embedded 1-dimensional graph in  $S^3$ . A graph  $G$  is said to be *good* if the degree of each vertex of  $G$  is greater than 1. In this article, we deal with good planar graphs, and our result obtained here can be generalized for more general good graphs. Without stated otherwise, all graphs are assumed to be good. Let  $\Gamma$  be a spatial

graph of a planar graph  $G$  embedded in  $S^3$ . We say  $\Gamma$  is *minimally knotted* if any proper subgraph  $\Gamma'$  is contained in a sphere in  $S^3$ , and  $\Gamma$  itself is not. A spatial graph  $\Gamma$  is said to be *totally knotted* if the exterior  $E(\Gamma)$  is irreducible and  $\partial$ -irreducible. By using some tangles with the Brunnian property, it can be shown that every planar graph has a spatial embedding which is minimally knotted and totally knotted. Inaba and Soma [26, Theorem 2], Kawauchi [35, Theorem 2.1] and Wu [86] showed that every planar graph has minimally knotted spatial embeddings with some additional conditions. On the other hand, it is easy to construct totally knotted spatial embeddings of every graph which are not minimally knotted by Myers' technique [57] or Kawauchi's [35, Theorem 1.1]. Together with a result of Scharlemann and Thompson [65, Theorem 7.5], the following is obtained by our result and the total knottedness is available under some weaker condition, as will be considered in §5.1.2.

**Theorem 5.1.2.** *Minimally knotted connected planar spatial graphs are totally knotted.*

Scharlemann and Thompson [65, Theorem 7.5] showed similar results, and gave an algorithm to detect the triviality of embedded planar graphs, via the extended Haken's algorithm [29], and Wu [87] reproved it and gave a necessary and sufficient condition for a planar graph in general 3-manifold to be minimally knotted in terms of "cycle-triviality".

It is noticed that Theorem 5.1.2 gives a convenient, sufficient condition for a spatial graph  $\Gamma$  to be totally knotted, namely  $E(\Gamma)$  is irreducible and  $\partial$ -irreducible. Now it is natural to ask the following.

**Question 5.1.3.** *Give a sufficient condition for spatial graphs to be acylindrical.*

Here we say a 3-manifold with non-empty boundary is acylindrical if it is irreducible,  $\partial$ -irreducible and does not contain essential tori nor annuli. By Thurston's hyperbolization result ([54], [70]), such a 3-manifold admits a complete hyperbolic structure with totally geodesic boundary. For example, see [31] and [72] for algorithms decomposing 3-manifolds into acylindrical 3-manifolds which are based on normal surface theory. In §5.1.2, several examples of minimally knotted spatial graphs are given. The spatial graphs illustrated in Figure 5.2 (A) and (C) are acylindrical ([70] and [56, Proposition 4.4] resp.), but the exterior of the graph shown in Figure 5.3 (A) contains essential annuli.

### 5.1.1 A sufficient condition

Let  $M$  be a compact, orientable 3-manifold. For a disjoint union  $J$  of simple closed curves in the boundary  $\partial M$ , the manifold obtained by attaching 2-handles  $D^2 \times I$ 's along  $J$  is denoted by  $M(J)$ . Let  $J = J_1 \cup \cdots \cup J_n$  be a disjoint union of simple closed curves, possibly empty (i.e.  $n = 0$ ), in  $\partial M$ .

We say  $(M, J)$  is *trivial* (otherwise it is *non-trivial*) if:

- (T.1) There are mutually disjoint essential disks  $D_1, \dots, D_n$  in  $M$  transverse to  $J$  such that  $|\partial D_i \cap J_j| = \delta_j^i$ , and

(T.2)  $M(J)$  is a 3-ball.

For our convenience, we say  $(M, J)$  is  $n$ -quasi-trivial provided that:

(Q.1) For some  $i$ , there is an essential disk  $D_i$  in  $M$  transverse to  $J$  with  $|\partial D_i \cap J_j| = \delta_j^i$ ,

(Q.2) The pair  $(M(J_i), J - J_i)$  is  $(n - 1)$ -quasi-trivial for  $i$  in (Q.1), and

(Q.3) If  $n = 0$ , then  $M$  is a 3-ball.

It is noticed that if  $(M, J)$  is trivial, then it is  $|J|$ -quasi-trivial and the genus of  $\partial M$  coincides the number of the components  $|J|$ . If  $(M, J)$  is  $n$ -quasi-trivial, then  $n = |J|$  and we say  $(M, J)$  is *quasi-trivial* simply.

We say  $(M, J)$  is *almost trivial* if:

(A.1) For any  $J_i \subset J$ ,  $(M(J_i), J - J_i)$  is trivial,

(A.2)  $(M, J)$  is not trivial. (By Lemma 5.1.6, we can replace this with that  $(M, J)$  is not quasi-trivial.)

We will prove Theorem 5.1.1 by applying Jaco's Handle Addition Lemma [32]. For a union  $J = J_1 \cup \cdots \cup J_n$  of mutually disjoint simple closed curves in  $\partial M$ , we put  $J^{(i)} = J - J_i$  and  $M^{(i)} = M(J_i)$ . The following result is known as the Handle Addition Lemma.

**Theorem 5.1.4 ([32]).** *Let  $M$  be an irreducible 3-manifold with compressible boundary and  $J$  be a simple closed curve in  $\partial M$ . If  $\partial M - J$  is incompressible, then  $\partial M(J)$  is incompressible.*  $\square$

Theorem 5.1.4 was generalized in several ways (see [46], [62]). The following is needed later.

**Lemma 5.1.5 ([46, Lemma 1.6], [62, Lemma 2.3]).** *Suppose  $\partial M - (J_1 \cup \cdots \cup J_n)$  is incompressible in  $M$  and  $\partial M - J^{(i)}$  is compressible in  $M$ , then for the manifold  $M^{(i)} = M(J_i)$ , it follows that  $\partial M^{(i)} - J^{(i)}$  is incompressible in  $M(J_i)$ .*  $\square$

In order to prove Theorem 5.1.1, we describe some properties of quasi-trivial pairs.

**Lemma 5.1.6.** *Let  $(M, J)$  be quasi-trivial. Then  $(M, J)$  is trivial and  $M$  is a handlebody.*

*Proof.* We prove this by induction on  $|J| = g(\partial M)$ . In the case  $n = 0$ , we are done by condition (Q.3). Suppose  $n > 0$ . We assume that an  $(n - 1)$ -quasi-trivial pair  $(M', J')$  is trivial and it is a handlebody. By condition (Q.2) and by the assumption of the induction,  $M(J_i)$  is a handlebody for some  $i$ . It is noticed that  $M$  is viewed as the exterior of a properly embedded arc  $\tau$  in a handlebody  $V$  and by condition (Q.1), there is a disk  $D$  properly embedded in  $V - \overset{\circ}{N}(\tau)$  such that  $D \cap \partial N(\tau)$  is a single arc and  $D \cap J' = \emptyset$ , where  $J'$  is a union of loops in  $\partial V$  corresponding to  $J - J_i$ . Let  $D'$  be the union of mutually

disjoint properly embedded disks in  $V$  corresponding to disks of condition (T.1) for  $(V, J')$ . We may assume  $D'$  and  $\tau$  are in general position and  $N(\tau) \cap D'$  consists of meridian disks of  $N(\tau)$ . By an innermost argument, we can isotope  $D$  so that  $D \cap D'$  consists of arcs.

Let  $\Delta$  be an outermost disk of  $D$  regarding  $D \cap D'$  and put  $\alpha = \Delta \cap \partial D$  and put  $\beta = \text{cl}(\partial \Delta - \alpha)$ . Notice that there are three possibilities for  $\Delta$  as follows: (A)  $\alpha \subset \partial N(\tau)$ , (B)  $\alpha$  consists of two connected arcs  $\alpha \cap \partial N(\tau)$  and  $\alpha \cap \partial V$ , and (C)  $\alpha \subset \partial V$ . In the case of (A), by sliding  $\tau$  along  $\Delta$ ,  $\tau$  is isotoped so that  $D \cap D'$  is reduced, and this isotopy preserves  $\partial V$ . In the case of (B),  $\tau$  is also isotoped so that  $D \cap D'$  is reduced by sliding along  $\Delta$ . Though this isotopy does not preserve  $\partial \tau$ , by condition (T.1),  $\alpha \cap \partial V$  does not meet  $J'$ . In the case (C), we can replace  $D'$  as follows. Let  $D_1$  and  $D_2$  be components of  $D'' - \beta$ , where  $D''$  is the component of  $D'$  containing  $\beta$ . By condition (T.1), we may assume that  $D_1$  does not meet  $J'$ . By removing  $D_1$  from  $D''$ , pasting  $\Delta$  and push slightly, we obtain the new disks  $D^*$  satisfying condition (T.1) and  $|D^* \cap D| < |D' \cap D|$ . Thus we may assume  $D' \cap D = \emptyset$ . Now  $D' \cup D$  satisfies condition (T.1), and  $V - \dot{N}(\tau)$  is a handlebody.  $\square$

**Lemma 5.1.7.** *Let  $(M, J)$  be almost trivial. For each handlebody  $M(J_i)$ , it follows that  $\partial M(J_i) - J^{(i)}$  is compressible in  $M(J_i)$ , or  $M(J_i)$  is a solid torus.*

*Proof.* By condition (Q.1) for  $M(J_i)$ , there is a disk  $D \subset M(J_i)$  such that  $D \cap J = D \cap J_j$  is a transverse point for some  $j$ . If  $M(J_i)$  is not a solid torus, the frontier  $\partial N(D \cup J_j)$  is actually a compression disk of  $\partial M(J_i) - J^{(i)}$ .  $\square$

**Lemma 5.1.8.** *For an almost trivial pair  $(M, J)$ ,  $M$  is irreducible and if  $M$  is not a handlebody, then  $\partial M - J$  is incompressible in  $M$ .*

*Proof.* By condition (Q.3), it follows that  $\partial M$  is connected and  $M$  can be embedded in  $S^3$ . Thus,  $M$  is irreducible.

Suppose  $\partial M - J$  is compressible in  $M$ . Since  $M$  is almost trivial, the manifold  $V = M(J)$  is a 3-ball by Lemma 5.1.6. Now  $M$  is viewed as the exterior of properly embedded arcs  $\tau_1, \dots, \tau_n$  in  $V$ , such that each meridian of  $\tau_i$  corresponds to  $J_i$ . Thus, any compression disk  $D$  for  $\partial M - J$  is isotoped so that  $\partial D \subset \partial V$ . Hence,  $D$  separates  $V$  into two 3-balls  $V_1$  and  $V_2$ . Let  $M_i$  denote the manifold corresponding to  $V_i$ .

Without loss of generality, we may assume  $\tau_1, \dots, \tau_m$  ( $m < n$ ) is contained in  $V_1$ , and the rest in  $V_2$ , after reordering if necessary. By condition (A.2),  $M(J_1)$  is  $(n-1)$ -quasi-trivial. Thus by Lemma 5.1.6,  $M(J_1)$  is a handlebody. Since  $M_2$  is a component of the cutting result of the handlebody  $M(J_1)$  along  $D$ ,  $M_2$  is a handlebody. Similarly,  $M_1$  is a handlebody. Thus  $M = M_1 \cup_D M_2$  is a handlebody. Hence if  $M$  is not a handlebody, then  $\partial M - J$  is incompressible.  $\square$

**Lemma 5.1.9.** *An almost trivial 3-manifold is irreducible and  $\partial$ -irreducible, or it is a handlebody.*



*Proof.* Let  $(M, J) = (M, J_1 \cup \dots \cup J_n)$  be an almost trivial pair. First, we prove in the case where  $g(\partial M) > 2$ .

Suppose that  $M$  is  $\partial$ -reducible. Let  $h$  be the number such that  $\partial M - (J - J_1 \cup \dots \cup J_h)$  is compressible and  $\partial M - (J - J_1 \cup \dots \cup J_{h-1})$  is incompressible in  $M$ . By the assumption that  $\partial M$  is compressible in  $M$  and by Lemma 5.1.8, such an  $h$  exists ( $2 \leq h \leq n$ ) if  $M$  is not a handlebody. Thus,  $\partial M(J_h) - (J - J_1 \cup \dots \cup J_h)$  is incompressible by Lemma 5.1.5. On the other hand,  $\partial M(J_h) - (J - J_h)$  is compressible in  $M(J_h)$  by Lemma 5.1.7, since  $M(J_h)$  is not a solid torus for  $g(\partial M) > 2$ . Since it follows that  $\partial M(J_h) - (J - J_h) \subset \partial M(J_h) - (J - J_1 \cup \dots \cup J_h)$ , the compression of  $\partial M(J_h) - (J - J_h)$  effects to  $\partial M(J_h) - (J - J_1 \cup \dots \cup J_h)$  in  $M(J_h)$ . This is a contradiction. Hence such an  $h$  does not exist. This shows that  $\partial M$  is incompressible in  $M$ .

Suppose  $g(\partial M) = 2$  and  $J = J_1 \cup J_2$ . Since  $(M, J)$  is almost trivial, and  $g(\partial M(J_i)) = 1$ , the manifold  $M(J_i)$  is a solid torus. By Lemma 5.1.8,  $\partial M - J$  is incompressible in  $M$ . Suppose  $\partial M - J_1$  is incompressible in  $M$ . By Theorem 5.1.4, it follows that  $\partial M(J_1)$  is incompressible in  $M(J_1)$ . This contradicts that  $M(J_1)$  is a solid torus. Hence  $\partial M - J_1$  is compressible, namely a compression disk  $D$  of  $\partial M$  can be chosen so that  $\partial D \cap J_1 = \emptyset$ . Similarly,  $\partial M - J_2$  is compressible and we let  $E$  be a compression disk of  $\partial M - J_2$ , possibly  $E \cap J_1 \neq \emptyset$ . Now  $M$  is viewed as the exterior of an arc  $\tau_1$  properly embedded in a solid torus  $V$  and  $J_2$  is considered to be a longitude of  $V$ . Thus,  $D$  is isotoped so that  $\partial D \subset \partial V$  since  $\partial D \cap J_1 = \emptyset$ . If  $D$  separates  $V$ , then  $V$  is separated into a 3-ball  $V_1$  and a solid torus  $V_2$  such that  $V_1$  contains  $\tau_1$ , and a meridian disk of  $V_2$  is a compression disk of  $\partial M - J_1$ . Hence we may assume  $D$  is non-separating, and it is a meridian disk of  $V$ . If  $M - \mathring{N}(D)$  is a solid torus, then  $M$  is a handlebody and we are done.

By the reason same as above,  $E$  can be assumed to be non-separating in  $M$ , and to have the algebraic intersection number  $\partial E \cdot J_1 = 1$  with  $J_1$ . Let us consider the intersection  $D \cap E$ . By an innermost argument, all circles of  $D \cap E$  are removed. Let  $\Delta$  be an outermost disk in  $D$ . Now  $E$  is  $\partial$ -compressed by  $\Delta$  to two disks  $E_1$  and  $E_2$ , possibly  $\partial E_i \cap J_2 \neq \emptyset$ . Without loss of generality, we may assume  $\partial E_1 \cdot J_1$  is odd since  $\partial E_1 \cdot J_1 + \partial E_2 \cdot J_1 = \partial E \cdot J_1$  is odd. Repeating such a  $\partial$ -compression, finally we get a properly embedded disk  $E'$  in  $M' = \partial M - \mathring{N}(D)$  with  $\partial E' \cdot J_1$  odd. This means that the disk  $E'$  is a non-separating compression disk of  $\partial M'$  in  $M'$ . Since  $M$  is irreducible,  $M'$  is also irreducible. Thus, the sphere obtained by compressing  $\partial M'$  along  $E'$  bounds a 3-ball in  $M'$  in the side not containing  $E'$ , it follows that  $M'$  is a solid torus. Hence,  $M = M' \cup N(D)$  is a handlebody of genus two and the conclusion follows in the case  $g(\partial M) = 2$ .

In the case where  $g(\partial M) = 1$ , it is easy to see that if  $M$  is not a solid torus, then it is a non-trivial knot exterior in  $S^3$  and it is  $\partial$ -irreducible.  $\square$

**Lemma 5.1.10.** *Let  $(M, J)$  be almost trivial. If  $M$  is a handlebody, then  $\partial M - J$  is compressible in  $M$ .*

*Proof.* If  $g(\partial M) = 1$ , then the pair  $(M, J)$  cannot be almost trivial since  $M$  is a non-trivial knot exterior or a trivial solid torus. Thus, we assume that  $g(\partial M) \geq 2$ . The proof is similar to that of Lemma 5.1.9. Suppose  $\partial M - J$  is incompressible in  $M$ . Let  $h$  be the number such that  $\partial M - (J_{h+1} \cup \dots \cup J_n)$  is compressible and  $\partial M - (J_h \cup \dots \cup J_n)$  is incompressible in  $M$ . Since  $M$  is a handlebody,  $\partial M$  is compressible in  $M$ . Thus, such an  $h$  exists. By Lemma 5.1.5,  $\partial M(J_h) - (J_{h+1} \cup \dots \cup J_n)$  is incompressible in  $M(J_h)$ . This contradicts Lemma 5.1.7, since  $(M(J_h), J - J_h)$  is  $(n - 1)$ -quasi-trivial by condition (A.1) and since the compression of  $\partial M(J_h) - (J - J_h)$  in  $M$  is also a compression of  $\partial M(J_h) - (J_{h+1} \cup \dots \cup J_n)$ .  $\square$

*Proof of Theorem 5.1.1.* By Lemma 5.1.9, the remainder case is where  $M$  is a handlebody. Assuming that  $M$  is a handlebody, we show  $(M, J)$  is a trivial pair.

In the case where  $n = 1$ , the conclusion follows since in this case  $M$  is a solid torus and  $J = J_1$  is a longitude, hence it is a trivial pair.

Since  $M(J)$  is a 3-ball,  $M$  is viewed as the exterior of properly embedded arcs  $\tau_1, \dots, \tau_n$  in a 3-ball  $V$ . By Lemma 5.1.10,  $\partial M - J$  is compressible in  $M$ . The compression disk  $D$  is isotoped so that  $\partial D \subset \partial V$  since  $\partial D \cap J = \emptyset$  and  $D$  cuts  $(M, J)$  into  $(M', J')$  and  $(M'', J'')$ . We assume that  $D$  is chosen so that the number  $|J''|$  is maximal among all such a compression disk. Since  $M = V - \mathring{N}(\tau_1 \cup \dots \cup \tau_n)$  is a handlebody, both parts  $M'$  and  $M''$  of  $M - \mathring{N}(D)$  are handlebodies. It is noticed that there exists a properly embedded disk  $D'$  in  $M$  such that for some, say  $J_1 \subset J'$ ,  $|D' \cap J| = |D' \cap J_1| = 1$  since by condition (A.1),  $M''(J'')$  is a 3-ball and  $J' \cap M'' = \emptyset$ . If  $J' = J_1$ , then it can be shown that  $(M, J)$  is quasi-trivial since  $(M'', J'')$  is quasi-trivial. If  $|J'| > 1$ , then we can choose  $D$  so that  $J''$  contains more components than above. This is a contradiction.  $\square$

Now the following is available. (cf. [13, Theorem 1])

**Theorem 5.1.11.** *Let  $(M, J)$  be such that for any  $J_i \subset J$ ,  $(M(J_i), J - J_i)$  is trivial. Then either*

- *If  $M$  is  $\partial$ -reducible, then  $M$  is a handlebody and  $(M, J)$  is trivial, or*
- *$M$  is  $\partial$ -irreducible.*

$\square$

## 5.1.2 Spatial graphs

Let  $\Gamma$  be a spatial graph in  $S^3$  of a connected graph  $G$ . For edges  $\mathcal{E} = \{e_1, \dots, e_n\}$  of  $\Gamma$ , we denote the simple closed curve in  $\partial E(\Gamma)$  corresponding to a meridian of  $e_i$  by  $e_i^*$ , and put  $\mathcal{E}^* = \{e_1^*, \dots, e_n^*\}$ . Then by the notion of 2-handle addition, we have  $E(\Gamma - \mathcal{E}) = E(\Gamma)(\mathcal{E}^*)$ . We use the same letters for the edges of  $\Gamma$  corresponding to edges of  $G$ . (cf. Figure 5.1)

A set of edges  $\mathcal{E}$  of  $G$  is called a *base edge system* of  $G$  if  $G - \mathcal{E}$  is connected and simply connected, and a set of edges  $\mathcal{E}$  of  $G$  is called a *base edge system*  $\Gamma$  if  $\Gamma - \mathcal{E}$  is connected and simply connected, equivalently  $E(\Gamma - \mathcal{E}) = E(\Gamma)(\mathcal{E}^*)$  is a 3-ball.

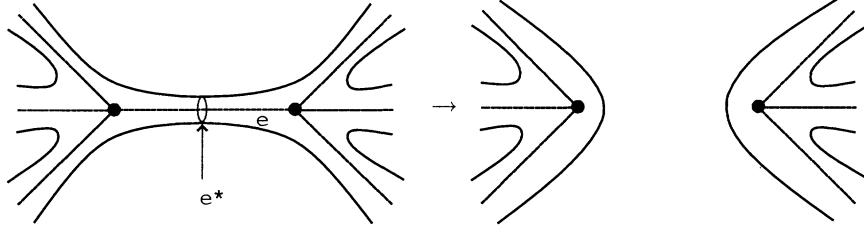

Figure 5.1:

**Lemma 5.1.12.** *Let  $\Gamma$  be a spatial graph in a sphere  $F$  in  $S^3$ . For any base edge system  $\mathcal{E} = \{e_1, \dots, e_n\}$  of  $\Gamma$ , the pair  $(E(\Gamma), \mathcal{E}^*)$  is trivial.*

*Proof.* By Lemma 5.1.6, it is sufficient to  $(E(\Gamma), \mathcal{E}^*)$  is quasi-trivial.

Let  $\Gamma_{\mathcal{E}}^*$  be the subgraph of the dual graph of  $\Gamma$  in  $F$  whose vertices are dual of all faces of  $F - \Gamma$  and edges consist of the dual of  $\mathcal{E}$ . Since  $\mathcal{E}$  is a base edge system,  $\Gamma - \mathcal{E}$  is simply connected.

First we claim that  $\Gamma^*$  contains a vertex of valence 1. Put  $v = |\mathfrak{V}(\Gamma)|$ ,  $e = |\mathfrak{E}(\Gamma)|$ ,  $f = |F - \Gamma|$ , and put  $v_{\mathcal{E}}^* = |\mathfrak{V}(\Gamma_{\mathcal{E}}^*)|$ ,  $e_{\mathcal{E}}^* = |\mathfrak{E}(\Gamma_{\mathcal{E}}^*)|$ . Since  $\Gamma$  is embedded in the sphere  $F$ , we have  $v - e + f = 2$ . Put  $g = 1 + e - v$ . Notice that  $g$  is equal to the genus of the handlebody  $N(\Gamma)$ . Hence, we have  $e_{\mathcal{E}}^* = g$ ,  $v_{\mathcal{E}}^* = f$  and  $v_{\mathcal{E}}^* = e_{\mathcal{E}}^* + 1$ . If we assume that all valences are greater than or equal to 2, then we have  $2v_{\mathcal{E}}^*/2 = v_{\mathcal{E}}^* \leq e_{\mathcal{E}}^*$ . This is a contradiction. Since  $E(\Gamma - \mathcal{E})$  is homeomorphic to a 3-ball, the subgraph  $\Gamma - \mathcal{E}$  does not contain any cycles. Hence, each face of  $F - \Gamma$  meets  $\mathcal{E}$ . Thus, each vertex of  $\Gamma_{\mathcal{E}}^*$  has non-zero valence.

Thus, the exterior  $E(\Gamma)$  contains a non-separating disk  $D$  coming from a face of  $F - \Gamma$  corresponding to a vertex with valence 1 of  $\Gamma_{\mathcal{E}}^*$  such that  $\partial D \cap \mathcal{E} = 1$ . Now it is easy to check that  $(E(\Gamma), \mathcal{E}^*)$  is quasi-trivial by induction on  $|\mathcal{E}|$ .  $\square$

Now we are in a position to show the following.

**Lemma 5.1.13.** *If  $\Gamma$  is a minimally knotted planar spatial graph, then for any base edge system  $\mathcal{E} = \{e_1, \dots, e_n\}$  of  $\Gamma$ , the pair  $(E(\Gamma), \mathcal{E}^*)$  is almost trivial.*

*Proof.* Since  $\Gamma$  is minimally knotted,  $\Gamma - e_i$  is in a sphere in  $S^3$ . By Lemma 5.1.12 and condition (A.1), we have  $(E(\Gamma - e_i), \mathcal{E} - e_i)$  is trivial. By [65, Theorem 7.5], if the exterior  $E(\Gamma)$  is a handlebody ( $\pi_1(E(\Gamma))$  is free), then  $\Gamma$  is trivial since  $\pi_1(E(\Gamma - e))$  is free for each non-separating edge  $e$  by the minimal knottedness. Thus,  $E(\Gamma)$  is not a handlebody. Hence  $(E(\Gamma), \mathfrak{E})$  is non-trivial by Lemma 5.1.6. Thus, it is an almost trivial pair.  $\square$

The converse is true in the following sense.

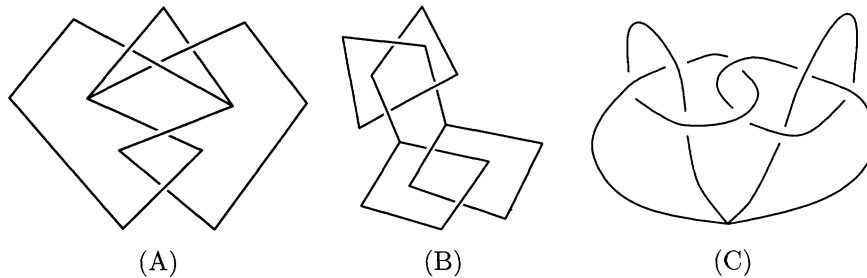

Figure 5.2:

**Proposition 5.1.14.** *For any almost trivial pair  $(M, J)$ , there exists a spatial graph  $\Gamma$  such that  $(E(\Gamma), \mathcal{E}^*) = (M, J)$  for some base edge system  $\mathcal{E}$  of  $\Gamma$ . In fact,  $\Gamma$  can be chosen to be a bouquet with  $n$  loops.*

*Proof.* Since  $M(J)$  is a 3-ball,  $M$  is the exterior of some properly embedded arcs  $\tau_1, \dots, \tau_n$  in a 3-ball  $B$ . Embedding  $(B, \tau)$  in  $S^3$  and shrinking  $B$  into a point, we obtain a bouquet  $\Gamma$  embedded in  $S^3$  such that  $E(\Gamma) = M$ . This completes the proof.  $\square$

**Theorem 5.1.15.** *Let  $\Gamma$  be a spatial graph. If  $\Gamma$  has a base edge system  $\mathcal{E}$  such that  $(E(\Gamma), \mathcal{E}^*)$  is almost trivial, then  $\Gamma$  is totally knotted.*

*Proof.* By Theorem 5.1.1,  $E(\Gamma)$  is irreducible and  $\partial$ -irreducible. Thus  $\Gamma$  is totally knotted.  $\square$

*Proof of Theorem 5.1.2.* This follows directly from Lemma 5.1.13 and Theorem 5.1.15.  $\square$

Here we give some examples of spatial graphs which are totally knotted. The  $\theta$ -curve  $\Gamma_1$  illustrated in Figure 5.2 (A) is known to be non-trivial ([37]), but is minimally knotted. The handcuff graph  $\Gamma_2$  embedded as shown Figure 5.2 (B) is not minimally knotted for the two loops  $e_1, e_2$  have linking number one. However it is not hard to see that the exterior  $M$  contains an incompressible torus, thus  $M$  is not a handlebody. On the other hand, taking meridians of  $e_1, e_2$  as  $J$ , it is clear that  $(M, J)$  is almost trivial. Hence by Theorem 5.1.15,  $\Gamma_2$  is totally knotted. The graph  $\Gamma_3$  illustrated in Figure 5.2 (C) is not minimally knotted, in fact, each subgraph is a trefoil knot and we cannot adapt Theorem 5.1.15, but it is totally knotted since  $E(\Gamma)$  is homeomorphic to the tangle space of the “true lover’s tangle”, which was proved by Myers [56, Proposition 4.1] to be atoroidal.

In [68], Taniyama gave a quick method to confirm the non-triviality of certain spatial graphs, and the graph illustrated in Figure 5.3 (C) is shown to be *irreducible* (see [68] for definition), thus it is non-trivial. Now it is easy to see that it is minimally knotted. Hence by Theorem 5.1.2, it is totally knotted. It is remarked that the exterior is homeomorphic to the tangle space illustrated in Figure 5.3 (D), and the tangle is non-trivial.

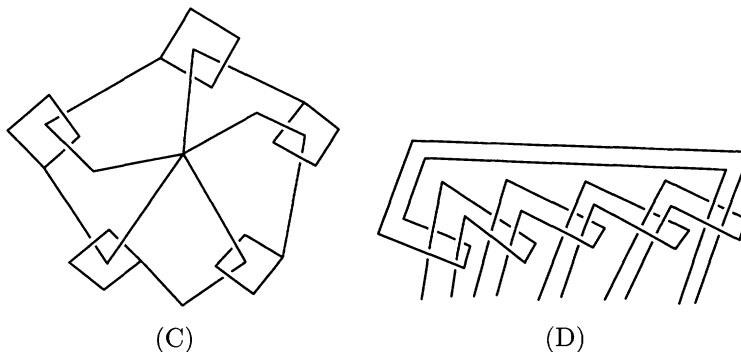

Figure 5.3:

## 5.2 Handle additions that produce products

Let  $F$  be a compact surface with non-empty boundary. It is easy to see that the product  $V = F \times I$  is a handlebody and  $V(\partial F \times \{1/2\})$  is a product  $F' \times I$ , where  $F'$  is a closed surface obtained from  $F$  by capping off with a disk. In this section, we show that the contrary is true in the following sense for  $\partial$ -reducible manifolds. See §5.2.1 for precise definitions.

**Theorem 5.2.1.** *Let  $M$  be a 3-manifold with connected boundary, and  $J = J_1 \cup \dots \cup J_n$  a disjoint union of simple closed curves  $J_i$ 's in  $\partial M$ . Let  $\ell$  be a simple closed curve in  $\partial M - J$  such that  $(M, J \cup \ell)$  forms a sutured manifold. Suppose for some surface  $F$ , there exists a homeomorphism  $f : F \times I \rightarrow M(\ell)$  with  $f(\partial F \times I) = N(J; \partial M)$ , then  $(M, J \cup \ell)$  is a product sutured handlebody, or  $\partial M - J$  is incompressible in  $M$  and  $(M, J)$  contains no monogon.*

In the case when  $J = \emptyset$ , we get the following consequence.

**Corollary 5.2.2.** *Let  $(M, \ell)$  be a sutured manifold with  $\ell$  connected. If  $M(\ell)$  is an  $I$ -bundle, then either  $(M, \ell)$  is a product sutured handlebody, or  $M$  is  $\partial$ -irreducible.  $\square$*

It is not difficult to construct a sutured manifold  $(M, J)$  such that  $J$  is connected and  $M$  is  $\partial$ -irreducible so that  $M(J)$  is a product. For example, one can construct such a sutured manifold by removing a “knotted arc” from a product. Furthermore, one can construct a hyperbolic one which yields a product, by removing an excellent arc [57, Theorem 1.1] from a product, or removing a hyperbolic imitation [35, Theorem 1.1] of, say, a vertical arc. It is remarked that Theorem 5.2.1 assures that if one obtains a product from a  $\partial$ -reducible manifold  $M$  by a single handle addition, then  $M$  is a handlebody.

Applications of Theorem 5.2.1 to Dehn surgery are observed as follows.

**Corollary 5.2.3.** *Let  $K$  be a knot in a closed 3-manifold  $M$  which bounds non-parallel incompressible Seifert surfaces  $S_1$  and  $S_2$  with  $S_1 \cap S_2 = \partial S_1 = \partial S_2 = K$ . If each cutting*

region of  $M$  along  $S_1 \cup S_2$  is  $\partial$ -reducible, then  $\hat{S}_1$  and  $\hat{S}_2$  are incompressible and non-parallel in  $\chi(M, (K, 0))$ .

Here  $\chi(M(K, 0))$  denotes the 0-framed surgery manifold and  $\hat{S}_i$  is the surface cupping  $S_i$  off with a meridian disk of the attached solid torus.

**Corollary 5.2.4.** *Let  $K$  be a knot in a homology sphere  $H$ . If the 0-framed surgery manifold  $\chi(H, (K, 0))$  fibers over  $S^1$ , then either  $K$  is a fibered knot, or  $K$  does not bound free incompressible Seifert surfaces. In fact, each incompressible Seifert surface for such a non-fibered knot  $K$  is totally knotted.*

These are not immediate consequences of Corollary 5.2.2, and we give short proofs in § 5.2.3 using Jaco's Handle Addition Lemma [32]. Gabai ([11, Corollary 8.19]) showed that a knot  $K$  in  $S^3$  is fibered if and only if the 0-framed surgery manifold fibers over  $S^1$ . It can be shown that some homology sphere contains a non-fibered knot which produces a surface bundle over  $S^1$  by 0-surgery. We say a Seifert surface  $S$  is *totally knotted* if the exterior  $E(S)$  is  $\partial$ -irreducible. By Corollary 5.2.4, each incompressible Seifert surface for such a non-fibered knot has a  $\partial$ -irreducible exterior.

This section is organized as follows. In § 5.2.1 and § 5.2.2, we prepare some lemmas which are needed to prove Theorem 5.2.1, and in § 5.2.3, we prove Theorem 5.2.1 and corollaries.

### 5.2.1 Gluing lemma

Through this section, all 3-manifolds are assumed to be compact and orientable, and all surfaces are compact and orientable. By a *sutured manifold*, we mean a pair  $(M, J)$  where  $M$  is a 3-manifold and  $J$  is a disjoint union of simple closed curves in  $\partial M$  such that  $J$  separated  $\partial M$  into two parts so that  $\partial M = \partial_+ M \cup \partial_v M \cup \partial_- M$ ,  $\partial_v M = N(J; \partial M)$  and each component of  $\partial_v M$  faces both a component of  $\partial_+ M$  and a component of  $\partial_- M$ . A sutured manifold  $(M, J)$  is called a *product* if there is a homeomorphism  $f : F \times I \rightarrow M$  with  $f(\partial F \times I) = N(J; \partial M)$  for some surface  $F$ .

We say a 3-manifold  $M$  is *irreducible* if every embedded sphere in  $M$  bounds a 3-ball in  $M$ . Let  $S$  be a surface properly embedded in  $M$  or contained in  $\partial M$ . We say  $S$  is *incompressible in  $M$*  if each component of  $S$  is not simply-connected and if  $D$  is a disk embedded in  $M$  with  $D \cap S = \partial D$ , then  $\partial D$  bounds a disk in  $S$ . We say  $S$  is  *$\partial$ -incompressible* if there is no embedded disk  $\Delta$  in  $M$  with  $\Delta \cap S = \alpha$  and  $\Delta \cap \partial M = \beta$  such that  $\partial \Delta = \alpha \cup \beta$  and  $\alpha$  is an essential arc in  $S$ .

For a disk  $D$  properly embedded in a 3-manifold  $M$  equipped with a disjoint union  $J$  of simple closed curves, we say  $D$  is a *monogon of  $(M, J)$*  if  $\partial D$  intersects  $J$  in a single transverse point. For a monogon  $D$  of  $(M, J)$ , we always assume that  $D \cap N(J; \partial M)$  consists of a single essential arc in  $N(J; \partial M)$ .

The following is a basic lemma concerning on the existence of  $\partial$ -reducing disk and monogons.

**Lemma 5.2.5.** *Let  $M$  be an irreducible 3-manifold. Let  $J$  be a disjoint union of simple closed curves in  $\partial M$ . If  $(M, J)$  contains a monogon and  $\partial M - J$  is incompressible, then  $M$  is a solid torus and  $J$  is a connected longitudinal curve.*

*Proof.* Let  $D$  be a monogon of  $(M, J)$ , and  $J'$  the component of  $J$  which meets  $\partial D$ . If  $\partial M - J$  is incompressible, then for the frontier  $D'$  of  $N(D \cup J'; M)$ ,  $\partial D'$  bounds a disk  $E$  in  $\partial M - J$  on the side not containing  $\partial D$ . By the irreducibility of  $M$ , the sphere  $D' \cup E$  bounds a 3-ball  $C$ . Thus  $M = C \cup N(D \cup J; M)$  turns out to be a solid torus and  $J$  is a longitude of  $M$ .  $\square$

We show the following lemma, so called a “gluing lemma”, which is needed later.

**Lemma 5.2.6.** *Let  $M$  be an irreducible 3-manifold which is not homeomorphic to a 3-ball, and  $J$  a disjoint union of simple closed curves in  $\partial M$  such that  $\partial M - J$  is incompressible and  $(M, J)$  has no monogon. Then for any two components  $J_1$  and  $J_2$  of  $J$ , for the manifold  $M'$  obtained from  $M$  by gluing  $N(J_1; \partial M)$  to  $N(J_2; \partial M)$ ,  $\partial M' - (J - J_1 - J_2)$  is incompressible in  $M'$  and  $(M', J - J_1 - J_2)$  has no monogon.*

*Proof.* Put  $J' = J - J_1 - J_2$ . First we show the incompressibility of  $\partial M' - J'$ . Let  $A$  be the properly embedded annulus in  $M'$  that is the gluing result of  $N(J_1; \partial M)$  and  $N(J_2; \partial M)$ . Since  $\partial M - J$  is incompressible, we can see that  $A$  is incompressible as follows. If  $A$  is compressible, we may assume that  $J_1$  bounds a disk in  $M$ . By the incompressibility of  $M - J$ ,  $J_1$  bounds disks in both side of  $\partial M - J_1$ . In this case  $(M, J)$  forms a  $D^2 \times I$  and this is a contradiction. Since  $(M, J)$  has no monogon,  $A$  is  $\partial$ -incompressible in  $M'$ . Let  $D$  be a compression disk of  $\partial M' - J'$ . If  $D \cap A = \emptyset$ , then it is not hard to see that  $D$  is a compression disk of  $\partial M - J$  in  $M$ . So, we assume  $D \cap A$  is non-empty and minimal among compression disks of  $\partial M' - J'$ . Since  $A$  is incompressible, any circle component of  $D \cap A$  is eliminated by innermost arguments. Let  $\Delta$  be an outermost disk in  $D$  with respect to  $D \cap A$ . Since  $A$  is essential,  $\Delta \cap A$  is an inessential arc in  $A$ . Thus we can  $\partial$ -compress  $D$  and obtain disks  $D_1$  and  $D_2$ . If none of  $D_1$  and  $D_2$  is a compression disk of  $\partial M' - J'$ , then  $\partial D$  bounds a disk in  $\partial M' - J'$  and this is a contradiction. Thus  $D_1$  is a compression disk with  $|D_1 \cap A| < |D \cap A|$ . This contradicts the minimality of  $|D \cap A|$ .

Next, we deal with monogons. Let  $D$  be a monogon of  $(M', J')$ . Let us consider the intersection  $D \cap A$ . Since  $(M, J)$  has no monogon,  $D \cap A \neq \emptyset$  and we assume  $|D \cap A|$  is minimal among all monogons of  $(M', J')$ . Let  $\Delta$  be an outermost disk in  $D$  with respect to  $D \cap A$ . We can take  $\Delta$  so that it does not meet  $J'$ . If  $A \cap \Delta$  is an essential arc in  $A$ , then  $\Delta$  is modified to a monogon of  $(M, J)$ . If  $A \cap \Delta$  is an inessential arc in  $A$ , then by a  $\partial$ -compression of  $D$ , we can find a new monogon  $D'$  with  $|D' \cap A|$  smaller than  $|D \cap A|$  and this contradicts the minimality.  $\square$

### 5.2.2 Sweeping out lemma

Let  $F$  be a compact surface, possibly  $\partial F \neq \emptyset$ . Put  $W = F \times I$  and  $\partial_i W = F \times \{i\}$  for  $i = 0, 1$ , and put  $\partial_v W = \partial F \times I$ ,  $\partial_h W = \partial_0 W \cup \partial_1 W$ . For a properly embedded circle or arc  $\sigma$  in  $F$ , the surface  $\sigma \times I \subset W$  is called a *vertical surface*. A vertical surface  $P$  is *essential* if it is incompressible and not  $\partial$ -parallel, or equivalently, the circle or arc  $\sigma$  corresponding to  $P$  is essential in  $F$ . Let  $\tau$  be a properly embedded arc in  $W$  such that  $\partial\tau \cap \partial_i W \neq \emptyset$  for  $i = 0, 1$ , and put  $E(\tau) = W - \mathring{N}(\tau)$ .

**Lemma 5.2.7.** *Let  $F$ ,  $W$ , and  $\tau$  be as above. Let  $P$  be an incompressible vertical surface in  $W$ . If  $\partial E(\tau) - \partial_v W$  is compressible in  $E(\tau)$  then  $\tau$  is isotoped so that  $\tau \cap P = \emptyset$ .*

*Proof.* We may assume that  $N(\tau) \cap P$  consists of meridian disks of  $N(\tau)$ . If  $N(\tau) \cap P = \emptyset$ , we are done. Thus assuming that  $N(\tau) \cap P \neq \emptyset$ , we shall show that  $N(\tau) \cap P$  can be reduced by an isotopy  $\tau$ .

For each component  $B$  of  $\partial E(\tau) - P$ , we may assume that  $B \cap D$  consists of essential arcs in  $B$  since if there is an inessential component, we can reduce  $|D \cap N(\tau)|$  by an isotopy on  $E(\tau)$ .

Let  $D$  be a compression disk of  $\partial E(\tau) - \partial_v W$ . We may assume that  $D$  and  $P$  are in general position and  $|D \cap P|$  is minimal among the choices of  $D$ , hence later we assume that  $c(\tau, P, D) = (|D \cap N(\tau)|, |N(\tau) \cap P|, |P \cap D|)$  is lexicographically minimal with respect to  $P$  and  $D$  for a fixed  $\tau$ , up to isotopy.

Let  $D'$  be an innermost disk in  $D$  with respect to  $D \cap P$ . Since  $P$  is incompressible in  $W$ ,  $\partial D'$  bounds a disk  $E$  in  $P$  and since  $W$  is irreducible, the sphere  $E \cup D'$  bounds a 3-ball. By an isotopy on  $W$  which moves  $D'$  to  $E$ , we can reduce  $D \cap P$ , without increasing  $|N(\tau) \cap P|$  since  $\mathring{D} \cap N(\tau) = \emptyset$ .

Hereafter we assume  $D \cap P$  consists of arcs.

Let  $\Delta$  be an outermost disk in  $D$  regarding  $D \cap P$ . We put  $\alpha = \partial\Delta \cap \partial D$  and  $\beta = \text{cl}(\partial\Delta - \alpha)$ . Notice that by the assumption that  $N(\tau) \cap P \neq \emptyset$ , we have that  $\alpha \cap N(\tau) \neq \emptyset$  and there are following four possibilities: (1)  $\beta$  connects distinct components of  $N(\tau) \cap P$ , (2)  $\partial\beta$  is contained in a component of  $N(\tau) \cap P$ , (3)  $\beta$  connects a component of  $N(\tau) \cap P$  and  $\partial P$ , and (4)  $\partial\beta \subset \partial P$ .

(1): By an isotopy along  $\Delta$ ,  $\tau$  is isotoped so that the two components of  $N(\tau) \cap P$  are removed.

(2): First we remark that each component  $\beta$  of type (2) is essential in  $P - \mathring{N}(\tau)$ . Therefore,  $D$  is  $\partial$ -compressed to two disks in  $E(\tau)$  one of which is  $\partial$ -reducing and has the smaller complexity than  $D$ . Now,  $\alpha$  consists of three parts  $\partial D \cap (\partial E(\tau) - N(\tau))$  and two components of  $D \cap N(\tau)$ . Let  $A$  be a component of the frontier  $\partial N(\tau) \cap \partial E(\tau)$  on  $N(\tau)$  which meets  $\alpha$ . Removing the meridian disk  $E$  of  $N(\tau)$  containing  $\partial\alpha$  from  $P$  and pasting  $A$ , we obtain a properly embedded surface  $P'$  in  $W$ . Then  $\Delta$  becomes a  $\partial$ -compression disk of  $P'$ .

If  $P$  is a vertical disk, then  $\beta$  is inessential in  $P - E$ . If  $P$  is a vertical annulus, then  $\beta$  is



inessential in  $P - E$  or essential. First we consider the inessential case. Since  $\beta$  is inessential in  $P - E$ , the arc  $\beta' = \beta \cup (\alpha \cap N(\tau))$  is also inessential in  $P'$  and put the bi-gonal disk  $\Delta'$  in  $P'$ . Since  $W$  is a product,  $\partial W_0$  is incompressible. Hence  $\partial(\Delta \cup \Delta')$  bounds a disk  $\Delta''$  in  $\partial_0 W$  which does not contain  $\partial_0 \tau$ . In this case there is an inessential component of  $D \cap \partial E(\tau) - \partial N(\tau)$  in  $\partial E(\tau) - \partial N(\tau)$  and this is a contradiction. Next we consider the case  $P$  is an annulus and  $\beta$  is essential in  $P - E$ . In this case, the  $\partial$ -compression of  $P'$  along  $\Delta$  gives two annuli, and one  $Q$  of them connects  $\partial_0 W$  and  $\partial_1 W$  and the other  $Q'$  is such that  $\partial Q' \subset \partial_0 W$ . It is noticed that  $Q$  is isotopic to  $P$  since  $W$  is an  $I$ -bundle. Hence,  $\tau$  is isotoped so that  $N(\tau) \cap P$  reduced as  $|N(\tau) \cap P| > |N(\tau) \cap Q|$ .

(3): By an isotopy along  $\Delta$ ,  $N(\tau) \cap P$  is reduced.

(4): Notice that  $\partial\beta$  lies in a component of  $P \cap \partial_h W$  and  $\beta$  is inessential in  $P$ . Let  $\Delta'$  be the bi-gonal disk in  $P$ . By the irreducibility of  $W$  and by the incompressibility of  $\partial W - N(\tau)$ ,  $\partial(\Delta \cup \Delta')$  bounds a disk in  $\partial W - N(\tau)$ . If  $\Delta' \cap \tau = \emptyset$ , then  $D$  is isotoped so that  $D \cap P$  is reduced. If  $\Delta' \cap \tau \neq \emptyset$ , then  $\tau$  is isotoped so that  $N(\tau) \cap P$  is reduced.

In either case, isotopies reducing each intersections reduce the complexity  $c(\tau, P, D)$  lexicographically. This completes the proof.  $\square$

### 5.2.3 Proof of Theorem 5.2.1

Let  $(M, J)$ ,  $\ell$  and  $F$  be as in Theorem 5.2.1. Then  $M$  is considered as the exterior of a properly embedded arc  $\tau$  in the product  $F \times I$ . We put  $\partial_0 \tau = \tau \cap F \times \{0\}$  and  $\partial_1 \tau = \tau \cap F \times \{1\}$ .

**Lemma 5.2.8.**  *$M$  is irreducible and  $\partial M - (J \cup \ell)$  is incompressible.*

*Proof.* Since  $M(\ell)$  is a product, it is irreducible. Actually  $M$  is obtained from  $M(\ell)$  by removing a connected properly embedded arc. Hence  $M$  is also irreducible.

Let  $D$  be a compression disk of  $\partial M - (J \cup \ell)$ . Without loss of generality, we may assume that  $\partial D$  is contained in  $F \times \{0\}$ . Since  $M(\ell)$  is a product,  $\partial D$  bounds a disk  $E$  in  $\partial M(\ell)$  such that  $E$  contains  $\partial_0 \tau$ . Since  $F \times I$  is irreducible, the sphere  $E \cup D$  bounds a 3-ball and  $D$  separates  $\partial_0 \tau$  and  $\partial_1 \tau$ . This can not occur since  $\tau \cap D = \emptyset$ .  $\square$

*Proof of Theorem 5.2.1.* By Lemma 5.2.8, it is sufficient to prove Theorem 5.2.1 under the assumption that  $M$  is irreducible and  $\partial M - (J \cup \ell)$  is incompressible. For a connected surface, we use the lexicographical complexity  $c(F) = (g(F), |\partial F|)$  and we prove Theorem 5.2.1 by induction on  $c(F)$ .

In the case when  $c(F) = (0, 1)$ ,  $F$  is a disk and  $M(\ell)$  is a 3-ball. If  $\partial M - J$  is compressible in  $M$ , then  $M$  is a solid torus and  $J$  is a longitude of  $M$ . Since  $\ell$  is disjoint from  $J$ ,  $\ell$  is parallel to  $J$  and  $M - J \cup \ell$  forms a product sutured handlebody and the conclusion follows.

Suppose  $c(F) > (0, 1)$ . We regard  $M$  as the exterior of a properly embedded arc  $\tau$  in a product  $W = F \times I$ . Since  $(M, J \cup \ell)$  forms a sutured manifold, it follows that  $\ell$

separates  $\partial M - J$ . Thus  $\tau$  joins  $F \times \{0\}$  to  $F \times \{1\}$ . By the assumption that  $c(F) > (0, 1)$ , we can take a non-separating essential vertical disk or annulus  $P$  in  $W$ . Assuming that  $\partial M - J$  is compressible in  $M$  or there is a monogon of  $(M, J)$ , we show that  $(M, J \cup \ell)$  is a product sutured handlebody. If there is such a monogon, then by Lemma 5.2.5,  $\partial M - J$  is compressible or  $M$  is a solid torus. However by the assumption  $c(F) > (0, 1)$ ,  $M$  cannot be a solid torus. Hence we may assume that  $\partial M - J$  is compressible. By Lemma 5.2.7, we can isotope  $\tau$  so that  $\tau$  and  $P$  are disjoint. Let  $M'$  be the cutting result of  $M$  along  $P$  and put  $J'$  be the disjoint union of simple closed curves in  $\partial M'$  which is naturally obtained from  $J$  which contains a new component corresponding to the cutting vertical surface  $P$ . Since  $\tau \cap P = \emptyset$ , we have that  $M'(\ell) = F' \times I$  where  $F'$  is the cutting result of  $F$  along the arc or circle  $\sigma$  in  $F$  which corresponds to  $P$ .

Since  $P$  is essential,  $\sigma$  is essential in  $F$ . Thus we have  $c(F) > c(F')$ . Now by the hypothesis on the induction,  $(M', J' \cup \ell)$  is a sutured handlebody or  $\partial M' - J$  is incompressible in  $M'$  and  $(M', J')$  has no monogon. In the former case, we can naturally extend the product structure of  $(M', J' \cup \ell)$  to  $(M, J \cup \ell)$  and the conclusion follows. In the latter case, Lemma 5.2.6 is adapted to show the incompressibility of  $M - J$  and there is no monogon for  $(M, J)$ . This is a contradiction and completes the proof.  $\square$

*Proof of Corollary 5.2.3.* The incompressibilities of  $\hat{S}_1$  and  $\hat{S}_2$  are assured by Handle Addition Lemma [32]. If  $S_1$  is parallel to  $S_2$ , then by Corollary 5.2.2, one of the cutting regions of  $M - S_1 \cup S_2$  forms a product sutured manifold. This contradicts the non-parallel condition for  $S_1$  and  $S_2$ .  $\square$

*Proof of Corollary 5.2.4.* Suppose that  $K$  bounds a non-totally knotted incompressible Seifert surface  $S$ . By Handle Addition Lemma [32],  $\hat{S}$  is incompressible in  $M$ . Since  $M$  is a homology handle and fibers over  $S^1$ , by an argument of [10, Lemma 3.4], each connected non-separating surface in  $M$  is isotopic to a fiber surface of the fibration over  $S^1$ . Thus,  $\hat{S}$  is a fiber surface. Since  $S$  is not totally knotted,  $E(S)$  is  $\partial$ -reducible. Thus by Corollary 5.2.2, the sutured manifold  $(E(S), \partial S)$  is productive and this means that  $K$  is a fibered knot. This completes the proof.  $\square$

## Chapter 6

# Surgery descriptions of homology spheres

Let  $H$  be an integral homology 3-sphere. A *framed knot* (*colored knot*, resp.) in  $H$  is a pair  $\mathcal{K} = (K, \gamma)$  such that  $K$  is a knot in  $H$  and  $\gamma$  is an integer (a rational  $\gamma = q/p$  or  $\infty$ , resp.) which is called the *framing for  $K$*  (*coloring for  $K$* , resp.). A *framed link* (*colored link*, resp.) is a link  $L = K_1 \cup \cdots \cup K_n$  with an  $n$ -tuple  $\mathcal{L} = (\mathcal{K}_1, \dots, \mathcal{K}_n)$  where  $\mathcal{K}_i = (K_i, \gamma_i)$  a framed knot (a colored knot) in  $H$ . We let  $E(L)$  denote the exterior  $H - \mathring{N}(L)$  of a link  $L$  in  $H$ . For a framed (colored, resp.) link  $\mathcal{L}$  in  $H$ , a simple closed curve  $l_i$  in each component of  $\partial E(L)$  corresponding  $\partial N(K_i)$  is determined uniquely by the framing  $\gamma_i$  for  $K_i$  so that  $lk(l_i, K_i) = \gamma_i$  in  $H$  ( $[l_i]$  represents the element  $(p_i, q_i) \in H_1(\partial N(K_i))$  where  $(1, 0)$  represents the homology class of the preferred longitude and  $(0, 1)$  the meridian of  $K_i$ .) By attaching a solid torus  $V_i$  to each component of  $\partial E(L)$  so that the boundary of a meridian disk of  $V_i$  is glued to  $l_i$ , we obtain a closed 3-manifold  $\chi(H; \mathcal{L}) = E(L) \cup \bigcup_{i=1}^n V_i$ , so called a *surgery manifold*, and the construction  $H \rightarrow \chi(H; \mathcal{L})$  is called *surgery along  $\mathcal{L}$* . It is known that any closed orientable 3-manifold is a surgery manifold of some framed link in  $S^3$ , and if two framed links determine the same surgery manifolds, then they are related by a finite sequence of Kirby moves [38].

Let  $\mathcal{K}_1 = (K_1, \gamma_1)$  and  $\mathcal{K}_2 = (K_2, \gamma_2)$  be framed knots yielding the same surgery manifold. Now it is natural to ask how the Conway polynomials  $\nabla_{K_1}(z)$  and  $\nabla_{K_2}(z)$  relate to each other.

Here we shall specify each framing to  $\pm 1$  and 0 to simplify arguments. The Alexander-Conway polynomial is a typical example of classical polynomial invariants for knots and links in homology spheres. See § 6.0.4 for precise and a review. We denote the coefficient of  $z^n$  of the Conway polynomial  $\nabla_K(z)$  by  $a_n(K)$ .

In the case when  $\gamma_1 = \gamma_2 = 0$ , the surgery manifold  $M$  is a *homology handle*, that is, a 3-manifold with the infinite cyclic homology group  $H_1(M) = \mathbb{Z}$ , and it is well-known

that the Conway polynomials of  $K_1$  and  $K_2$  coincide and the polynomial is called the *associated Conway polynomial of  $M$* . There are several works concerning about constructing non-equivalent knots which yield the same homology handle by 0-framed surgery. In [69], Teragaito gave finite sequences of pairwise distinct such satellite knots of arbitrarily large numbers, and in [36], Kawauchi constructed mutative hyperbolic knots such that they yield the same homology handle and non-isometric but mutative 1-surgery hyperbolic homology spheres. In [78], we gave a method to construct an infinite sequence of mutually non-equivalent hyperbolic knots producing the same homology handle, and the “infinite part” was based on a finiteness result on incompressible surfaces in 3-manifolds ([72], [73]) and the rigidity of hyperbolic 3-manifolds. Such a phenomenon was first discovered by J. Osoinach in his Thesis.

In the case when  $\gamma_1 = \varepsilon_1$  and  $\gamma_2 = \varepsilon_2$  where  $\varepsilon_i \in \{-1, 1\}$ , the surgery manifold  $M$  is an integral homology sphere. In 1985, A. Casson introduced an integer valued invariant for integral homology spheres, which is called the *Casson invariant* and denoted by  $\lambda(M)$ , and which has good relationships and aspects between linking theory, Dehn surgery and  $SU(2)$ -representations of the fundamental groups. See [2] and [64] for a review and see [82], [48] for more general surgery formula and extension of Casson invariant for general 3-manifolds. By Casson’s surgery formula ([2], [64]) we have  $\varepsilon_1 a_2(K_1) = \varepsilon_2 a_2(K_2)$  and the value coincides with the difference  $\lambda(M) - \lambda(H)$  of the Casson invariants.

In this section, we show that there is no restriction to coefficient of higher degree of Conway polynomials under  $(\pm 1)$ -surgery in the sense as follows:

**Theorem 6.0.9.** *Let  $H$  be an integral homology sphere. Let  $f_1(z) = \sum_{i=2}^n c_i z^{2i}$  and  $f_2(z) = \sum_{i=2}^m d_i z^{2i}$  be two polynomials in  $z^2$ . For any  $\varepsilon_1, \varepsilon_2 \in \{-1, 1\}$  and for any integer  $a \in \mathbb{Z}$ , there exist framed knots  $\mathcal{K}_1 = (K_1, \varepsilon_1)$  and  $\mathcal{K}_2 = (K_2, \varepsilon_2)$  in  $H$  such that  $\nabla_{K_1}(z) = 1 + \varepsilon_2 a z^2 + f_1(z)$ ,  $\nabla_{K_2}(z) = 1 + \varepsilon_1 a z^2 + f_2(z)$ , they define the same surgery homology sphere  $\chi(H; \mathcal{K}_i) = H'$  and  $\varepsilon_1 \varepsilon_2 a = \lambda(H') - \lambda(H)$ .*

For example, let  $K_1$  be the knot  $8_{20}$  in the Rolfsen table [63] and  $K_2$  be the knot as shown in Figure 6.1. Then  $\chi(S^3; (K_1, -1)) = \chi(S^3; (K_2, -1))$  and since they have distinct Conway polynomials,  $\chi(S^3; (K_1, 0))$  is not homeomorphic to  $\chi(S^3; (K_2, 0))$ . In fact, it is observed that  $K_1$  is a fibered knot of genus two and thus  $\chi(S^3; (K_1, 0))$  is a closed surface bundle over  $S^1$ . On the other hand, since the leading coefficient of the Conway polynomial  $\nabla_{K_2}(z)$  is equal to 2 ( $\neq \pm 1$ ),  $K_2$  is non-fibered and thus by a result of Gabai [11, Corollary 8.19],  $\chi(S^3; (K_2, 0))$  is not a surface bundle over  $S^1$ .

This section is organized as follows. In § 6.0.4, we give a short review of Alexander-Conway polynomials and show some basic lemmas. In § 6.0.5, we give a method to construct knots realizing a given Conway polynomial via Seifert matrices. Proof of Theorem 6.0.9 and its application to a surgery description of homology spheres regarding Alexander polynomials are given in § 6.0.6, and some general arguments and problems concerning on more than three polynomials and  $(1/n)$ -surgeries are given in § 6.0.7.

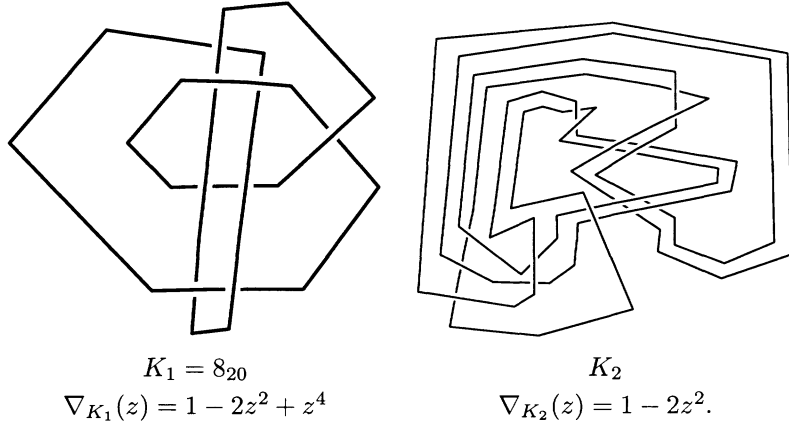

They define the same  $(-1)$ -surgery manifold, but 0-surgery manifolds are not homeomorphic. In fact,  $\chi(S^3; (K_1, 0))$  fibers over  $S^1$  and  $\chi(S^3; (K_2, 0))$  does not.

Figure 6.1:

#### 6.0.4 Preliminaries

All coefficients of homology groups are assumed to be integers  $\mathbb{Z}$  and a homology sphere means an integral homology sphere.

Let  $H$  be an integral homology sphere. It is known that any knot or link  $L$  bounds a *Seifert surface*  $S$ , that is, a compact connected orientable 2-manifold  $S$  embedded in  $H$  with  $S \cap L = \partial S = L$ . Furthermore if  $L$  is oriented, there is an oriented Seifert surface for  $L$  which induces the orientation of  $L$ . Such an oriented Seifert surface is called an *oriented Seifert surface for  $L$* . Later we assume any Seifert surface for an oriented link is oriented. A family  $\vec{v} = (J_1, \dots, J_n)$  of oriented simple closed curves  $J_i$ 's in  $S$  is called a *basis of  $S$*  (or  $H_1(S)$ ) if the homology classes  $[J_1], \dots, [J_n]$  generates  $H_1(S)$  and  $n = \text{rank}(H_1(S))$ . For a simple closed curve  $J$  in  $S$ , we denote  $J^+$  a simple closed curve in  $H$  which is obtained from  $J$  by a pushing forward to the positive side of  $S$ .

Let  $L$  be an oriented link and  $S$  be a Seifert surface for  $L$ . Let  $\vec{v} = (v_1, \dots, v_n)$  be a basis of  $H_1(S)$ . We denote the matrix  $(lk(v_i, v_j^+))$  by  $V_{S, \vec{v}}$ , or simply by  $V_S$  and call it the associated *Seifert matrix* of  $S$ . The polynomial  $\det(\sqrt{t}V_S - 1/\sqrt{t}V_S^T)$  is called the *Alexander polynomial of  $L$  associated with  $S$* . It is known that the associated Alexander polynomials are independent of the choice of  $S$  and  $\vec{v}$ , and the polynomial is called the *Alexander polynomial of  $L$*  and it is denoted by  $\Delta_L(t)$ . (See [64, Lecture 7], [48, Appendix] for details.)

For a link  $L$  in  $H$  and a colored knot  $\mathcal{K}$  in  $H$  which is disjoint from  $L$ , we let  $\chi(L; \mathcal{K})$  denote the link in  $\chi(H; \mathcal{K})$  which is obtained from  $L$  by surgery along  $\mathcal{K}$ . In particular, it is

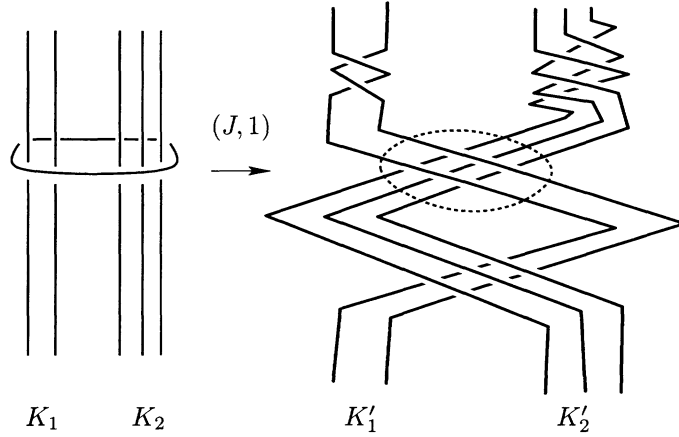

Figure 6.2:

noticed that if  $\mathcal{K} = (K, 1/n)$  and  $K$  is a trivial knot, then the  $\chi(H; \mathcal{K})$  is homeomorphic to  $H$  and  $L' = \chi(L; \mathcal{K})$  is obtained from  $L$  by  $(-n)$ -full twists along  $K$ .

In the rest of this section, we show some basic lemmas which are needed later.

**Lemma 6.0.10.** *Let  $K_1$  and  $K_2$  be two disjoint knots in  $H$ . Let  $(J, \varepsilon)$  be a  $1/n$ -colored knot in  $H$  disjoint from the link  $K_1 \cup K_2$ . Then in the surgery manifold  $H' = \chi(H; (J, 1/n))$ , it follows that:*

$$\begin{aligned} & lk_{H'}(\chi(K_1; (J, 1/n)), \chi(K_2; (J, 1/n))) \\ &= lk_H(K_1, K_2) - n \cdot lk_H(K_1, J) \cdot lk_H(K_2, J). \end{aligned}$$

*Proof.* This follows by a homological argument. (cf. Figure 6.2. Crossings encircled contribute  $-lk(K_1, J)lk(K_2, J)$ .)  $\square$

It is known that the *Conway polynomial*  $\nabla_L(z)$  and the *Alexander polynomial*  $\Delta_L(t)$  has the Skein relation as shown in Figure 6.3 [64, Theorem 7.6], they are related to each other via  $z = -(\sqrt{t} - 1/\sqrt{t})$  and  $\frac{1}{2}\Delta_L''(1)$  is equal to the coefficient  $a_2(L)$  of  $z^2$  in  $\nabla_L(z)$ .

**Lemma 6.0.11.** *Let  $L$  be an oriented link in  $H$ . Let  $c$  be an oriented trivial knot in  $H$  such that for a disk  $D$  bounded by  $c$  in  $H$ ,  $L$  intersects  $D$  in two transversal points with algebraic intersection number 0. Let  $L'$  be the oriented link obtained from  $L$  by performing a single  $+/-$ full twist along  $c$ . Then it follows that*

$$\nabla_{L \cup c}(z) = z(\nabla_{L'}(z) - \nabla_L(z)).$$

*Proof.* This follows directly from the Skein relation as shown in Figure 6.4.  $\square$

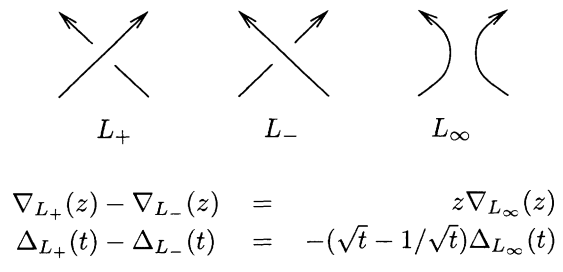

Figure 6.3:

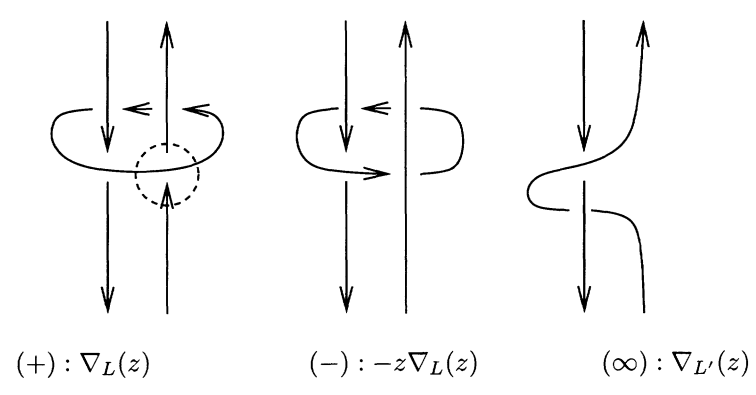

Figure 6.4:

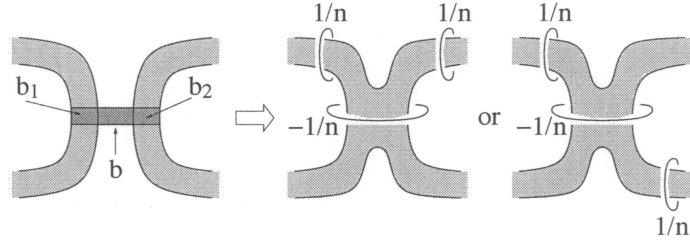

Figure 6.5:

### 6.0.5 Semi standard forms of Seifert matrices and realizing Conway polynomials

Let  $L$  be a link in a homology sphere  $H$ . An embedded disk  $b$  in  $H$  is called a *band* for  $L$  if  $b \cap L \subset \partial b$ ,  $b \cap L$  consists of two arcs and  $\partial b - L$  consists of two open arcs. For a band  $b$  for  $L$ , we put  $\partial_L b = b \cap L$  and  $\partial_{\bar{L}} b = \text{cl}(\partial b - \partial_L b)$  and we call the link  $L_{\#b} = L - \partial_L b \cup \partial_{\bar{L}} b$  a *band-modification of  $L$  along  $b$* . We say a band  $b$  for an oriented link  $L$  is *coherent* if the orientation of  $L$  induces an orientation of  $b$  via  $b \cap L$ . If  $b$  is coherent, then we give the orientation induced from  $L$  to  $L_{\#b}$ . By a homological reason, a coherent band  $b$  for an oriented link  $L$  is contained in an oriented Seifert surface  $S$  for  $L$  so that  $S - b$  is connected.

Let  $L = L_1 \cup L_2$  be an oriented split link and let  $Q$  be the splitting sphere. An oriented link  $L_X$  is *obtained from  $L$  by an  $X_n$ -composition* if there are coherent bands  $b_1$  for  $L_1$  and  $b_2$  for  $L_2$  with  $b_i \cap Q = \emptyset$  such that there is a coherent band  $b$  for  $L$  satisfying that  $|b \cap Q| = 1$ ,  $b_1 \cup b \cup b_2$  is connected and  $\partial_L b \subset \partial_{L_1} b_1 \cup \partial_{L_2} b_2$ , and further  $L_X$  is obtained from  $L_{\#b}$  by surgery along the three component trivial link as shown in Figure 6.5 or equivalently obtained from  $L_{\#b}$  by performing full  $n$ -twists and  $-n$ -twists along the three circles in Figure 6.5 in correspondence. In this case, we call  $L_X$  an  $X_n$ -composition of  $L_1$  and  $L_2$  along  $(b_1, b_2, b)$ . It is remarked that in the case  $n = 0$  and  $L$  consists of two components, an  $X_0$ -composition is the connected sum.

We see the Alexander-Conway polynomials behave under  $X_n$ -compositions as follows.

**Lemma 6.0.12.** *Let  $L_X$  be an  $X_n$ -composition of  $L_1$  and  $L_2$  along  $(b_1, b_2, b)$ . Then we have  $\nabla_{L_X}(z) = \nabla_{L_1}(z)\nabla_{L_2}(z) - n^2 z^2 \nabla_{L_1 \# b_1}(z)\nabla_{L_2 \# b_2}(z)$ .*

*Proof.* Since  $b_i$  is contained in a Seifert surface  $S_i$  for  $L_i$  so that the closure  $S'_i$  of  $S_i - b_i$  is connected, we can choose a basis  $\vec{x}_i$  for  $H_1(S_i)$  such that for some element of  $\vec{x}_i$  is a dual of the core of  $b_i$ . Hence for some Seifert matrices  $V_{S_i}$  and  $V_{S'_i}$  for  $L_i$  and  $L_{i \# b_i}$  respectively, it follows that  $V_{S'_i}$  is the corresponding submatrix of  $V_{S_i}$ . Thus  $L_X$  has the Seifert form  $V_S$  as



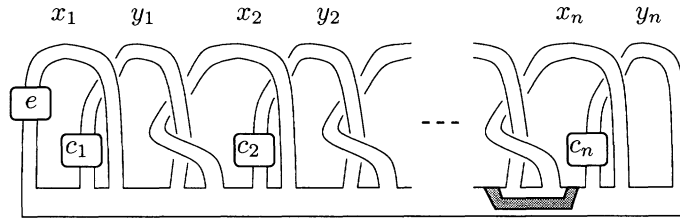

$$\nabla_{K_n^e(c_1, \dots, c_n)}(z) = 1 - e \sum_{i=1}^n c_i (-z^2)^i$$

Figure 6.6:

follows:

$$V_S = \begin{pmatrix} V_{S_1} & n & O \\ O & n & V_{S_2} \end{pmatrix}.$$

Thus, we have

$$\begin{aligned} \Delta_{L_X}(t) &= \det(\sqrt{t}V_S - 1/\sqrt{t}V_S^T) \\ &= \det(\sqrt{t}V_{S_1} - 1/\sqrt{t}V_{S_1}^T) \det(\sqrt{t}V_{S_2} - 1/\sqrt{t}V_{S_2}^T) \\ &\quad - n^2(\sqrt{t} - 1/\sqrt{t})^2 \det(\sqrt{t}V_{S_1'} - 1/\sqrt{t}V_{S_1'}^T) \det(\sqrt{t}V_{S_2'} - 1/\sqrt{t}V_{S_2'}^T) \\ &= \Delta_{L_1}(t)\Delta_{L_2}(t) - n^2(\sqrt{t} - 1/\sqrt{t})^2 \Delta_{L_1 \# b_1}(t)\Delta_{L_2 \# b_2}(t). \end{aligned}$$

Hence, we can conclude  $\nabla_{L_X}(z) = \nabla_{L_1}(z)\nabla_{L_2}(z) - n^2z^2\nabla_{L_1 \# b_1}(z)\nabla_{L_2 \# b_2}(z)$ .  $\square$

Here we give two kind of examples of unknotting number one knots, one is obtained by a suitable  $X_n$ -compositions from a trivial knot and the other is useful to study  $C_n$ -moves, each of which matches an arbitrarily given Conway polynomial and has a suitable Seifert surface to prove Theorem 6.0.9.

Several results are observed on constructing knots  $K$  with the polynomial invariant coincides with an arbitrarily given polynomial. In [9], Fujii showed for a given Alexander polynomial  $\Lambda(t)$  of some knot, there exist infinitely many 3-bridge, tunnel number one, and unknotting number one knots  $K$  such that  $\Delta_K(t) = \Lambda(t)$ , by constructing concrete examples. See [9] for more references.

Let  $K_n^e(c_1, \dots, c_n)$  be the knot illustrated in Figure 6.6, where  $\boxed{m}$  represents the  $m$ -full-twists of two arcs and let  $L_n^e(c_1, \dots, c_n)$  be the link illustrated in Figure 6.7.

**Proposition 6.0.13.**  $\nabla_{K_n^e(c_1, \dots, c_n)}(z) = 1 - e \sum_{i=1}^n c_i (-z^2)^i$ .

*Proof.* Let  $A(m)$  be an  $m$ -twisted oriented trivial annulus. Then  $\nabla_{\partial A(m)}(z) = -mz$ .

We show Proposition 6.0.13 by induction on  $n$ . If  $n = 1$ , then  $K_1^e(c_1)$  has the Seifert form  $V_F = ((e, 1), (0, c_1))$  and thus  $\nabla_{K_1^e(c_1)}(z) = \det(V_F) = 1 + ec_1z^2$ .

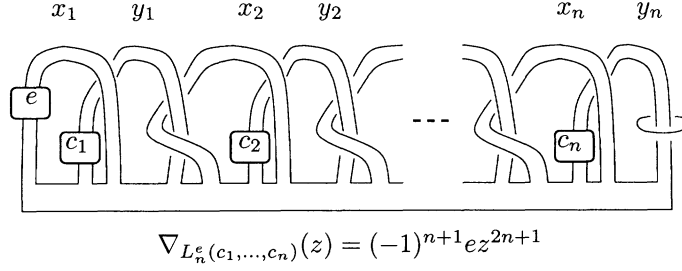

Figure 6.7:

Suppose  $n > 1$ . It is not hard to see that  $K_n^e(c_1, \dots, c_n)$  is obtained from  $K_{n-1}^e(c_1, \dots, c_{n-1})$  and a trivial knot  $K_1^0(c_n)$  by an  $X_{-1}$ -composition. The dual band is indicated in Figure 6.6. Hence by Lemma 6.0.12, if  $n = 2$ , then we have

$$\begin{aligned} \nabla_{K_2^e(c_1, c_2)}(z) &= \nabla_{K_1^e(c_1)}(z) \nabla_{K_1^0(c_2)}(z) - z^2 \cdot (-ez) \cdot (-c_2 z) \\ &= 1 + ec_1 z^2 - ec_2 z^4 \end{aligned}$$

and the conclusion follows.

If  $n > 2$ , then we have

$$\begin{aligned} \nabla_{K_n^e(c_1, \dots, c_n)}(z) &= \nabla_{K_{n-1}^e(c_1, \dots, c_{n-1})}(z) \nabla_{K_1^0(c_n)}(z) \\ &\quad - z^2 \nabla_{L_{n-2}^e(c_1, \dots, c_{n-2+1})}(z) \nabla_{\partial A(c_n)}(z). \end{aligned}$$

By the hypothesis on the induction and by Lemma 6.0.11, we have

$$\begin{aligned} \nabla_{L_{n-2}^e(c_1, \dots, c_{n-2+1})}(z) &= z(\nabla_{K_{n-2}^e(c_1, \dots, c_{n-2+2})}(z) - \nabla_{K_{n-2}^e(c_1, \dots, c_{n-2+1})}(z)) \\ &= z(-e(-z^2)^{n-2}) = -ez \cdot (-z^2)^{n-2}. \end{aligned}$$

Hence it satisfies that

$$\begin{aligned} \nabla_{K_n^e(c_1, \dots, c_n)}(z) &= 1 - e \sum_{i=1}^{n-1} c_i (-z^2)^i - z^2 \cdot (-ez \cdot (-z^2)^{n-2}) \cdot (-c_n) z \\ &= 1 - e \sum_{i=1}^{n-1} c_i (-z^2)^i - ec_n (-z^2)^n = 1 - e \sum_{i=1}^n c_i (-z^2)^i. \end{aligned}$$

This completes the proof. □

Now we have:

**Proposition 6.0.14.**  $\nabla_{L_n^e(c_1, \dots, c_n)}(z) = (-1)^{n+1} e z^{2n+1}$ . □

Let  $K_n(c_1, \dots, c_n)$  denote the knot as shown in Figure 6.8. This kind of knot was arose in a study of variations of the coefficients of Conway polynomials in terms of  $C_n$ -moves.

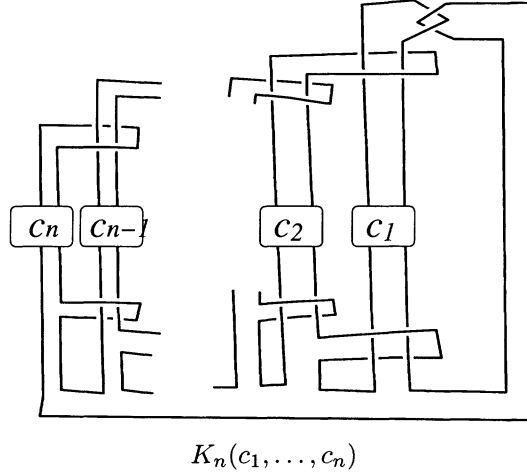

Figure 6.8:

**Proposition 6.0.15.**  $\nabla_{K_n(c_1, \dots, c_n)}(z) = \nabla_{K_n^1(c_1, \dots, c_n)}(z) = 1 + \sum_{i=1}^n (-1)^{i-1} c_i z^{2i}$ .

*Proof.* By spanning a Seifert surface  $S$  for  $K_n(c_1, \dots, c_n)$  and taking a basis of  $H_1(S)$  as shown in Figure 6.9, it is noticed that the Seifert form  $V_S$  and that of  $K_n^1(c_1, \dots, c_n)$  coincide. Now by Proposition 6.0.13, the conclusion follows.  $\square$

*Remark 6.0.16.* Each of  $K_n^{\pm 1}(c_1, \dots, c_n)$  and  $K_n(c_1, \dots, c_n)$  is of unknotting number one.

For one's convenience, we state the following:

**Proposition 6.0.17.** Let  $V$  be the following  $2n \times 2n$ -matrix:

$$V = \begin{pmatrix} e & 1 & 0 & 0 & 0 & \cdots & 0 & 0 & 0 \\ 0 & c_1 & 1 & 0 & 0 & \cdots & 0 & 0 & 0 \\ 0 & 1 & 0 & 1 & 0 & \cdots & 0 & 0 & 0 \\ 0 & 0 & 0 & c_2 & 1 & \cdots & 0 & 0 & 0 \\ 0 & 0 & 0 & 1 & 0 & \cdots & 0 & 0 & 0 \\ \vdots & \vdots & \vdots & \vdots & \vdots & & \vdots & \vdots & \vdots \\ 0 & 0 & 0 & 0 & 0 & \cdots & c_{n-1} & 1 & 0 \\ 0 & 0 & 0 & 0 & 0 & \cdots & 1 & 0 & 1 \\ 0 & 0 & 0 & 0 & 0 & \cdots & 0 & 0 & c_n \end{pmatrix}.$$

Then  $\det(\sqrt{t}V - 1/\sqrt{t}V^T)|_{z=-\sqrt{t+1}/\sqrt{t}} = 1 - e \sum_{i=1}^n c_i (-z^2)^i$ .  $\square$

### 6.0.6 Proof of Theorem 6.0.9 and its application

*Proof of Theorem 6.0.9.* Let  $L = C_1 \cup C_2$  be the two-component link as shown in Figure 6.10 where  $c'_1$  and  $d'_1$  are integers such that  $c'_1 + d'_1 = -a$ ,  $c'_i = (-1)^i \varepsilon_2 c_i$  and  $d'_i = (-1)^i \varepsilon_1 d_i$

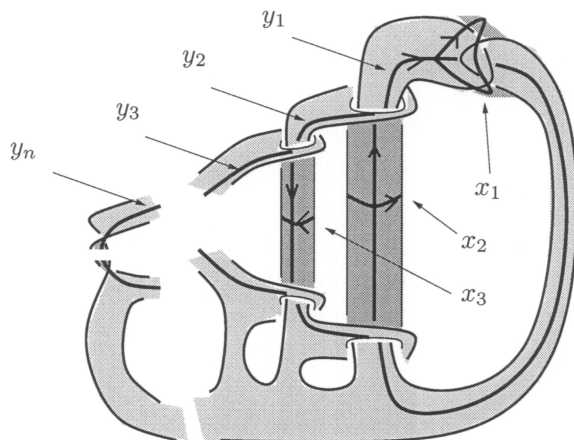

Figure 6.9:

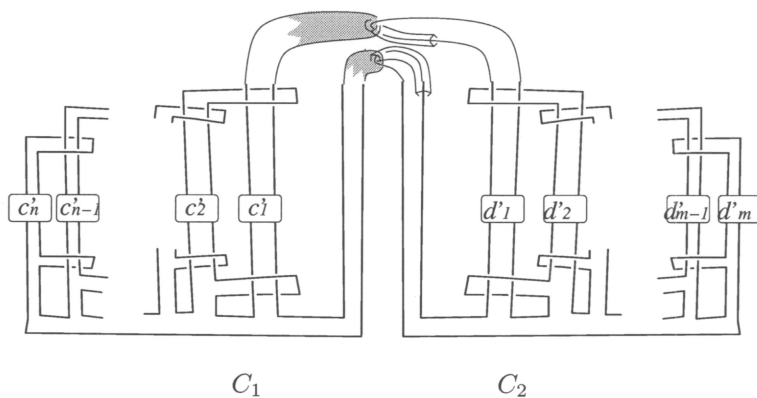

Figure 6.10:

for  $i > 1$ . We span a Seifert surface to  $C_1$  in a way similar to as shown in Figure 6.9, and perform a peripheral tubing on the side indicated in Figure 6.10. We let  $S_1$  denote the Seifert surface for  $C_1$  which is disjoint from  $C_2$  obtained in this manner. We take a basis  $\vec{x} = (x_1, y_1, x_2, y_2, \dots, x_n, y_n)$  of  $H_1(S_1)$  so that  $x_2, y_2, \dots, x_m, y_m$  are same as in Figure 6.9 and  $x_1$  is a meridian of the tube and  $y_1$  is a longitude of the tube such that  $lk(y_1, C_1) = 0$ . Now we have the Seifert form for  $\vec{x}$  same as that of  $K_n^0(a, c'_2, \dots, c'_n)$ .

After performing surgery on the framed knot  $(C_2, \varepsilon_2)$ , we obtain a framed knot  $(K_1, \varepsilon_1)$  from  $(C_1, \varepsilon_1)$  with Seifert form same as that of  $K_n^{-\varepsilon_2}(a, c'_2, \dots, c'_n)$ . Here we remark that the ambient manifold is unchanged since  $C_2$  is a trivial knot. Now it follows that  $\nabla_{K_1}(z) = 1 + \varepsilon_2(az^2 + \sum_{i=2}^n (-1)^{i-1} c'_i z^{2i}) = 1 + \varepsilon_2 az^2 + \sum_{i=2}^n c_i z^{2i}$  by Proposition 6.0.15. By the same argument, we get a framed link  $(K_2, \varepsilon_2)$  from  $(C_2, \varepsilon_2)$  by surgery along  $(C_1, \varepsilon_1)$  such

that  $\nabla_{K_2}(z) = 1 + \varepsilon_1(az^2 + \sum_{i=2}^m (-1)^{i-1} d'_i z^{2i}) = 1 + \varepsilon_1 az^2 + \sum_{i=2}^m d_i z^{2i}$ .

It is noticed that  $H' = \chi(H; (K_1, \varepsilon_1)) = \chi(H; (K_2, \varepsilon_2)) = \chi(H; (C_1, \varepsilon_1) \cup (C_2, \varepsilon_2))$  and by Casson's surgery formula, we have  $\lambda(H') - \lambda(H) = \varepsilon_1 \varepsilon_2 a$ . This completes the proof.  $\square$

It is well known that each homology sphere is obtained from  $S^3$  by a finite number of  $(\pm 1)$ -surgeries on knots ([2], [64]). In [47], Lescop showed that two integral homology spheres have the same Casson invariant if and only if they are related by a finite sequence of  $(\pm 1)$ -surgery on knots each of which has the Alexander polynomials which is equal to 1. In [27], Ishiwata generalized this result showing that, using [47, Theorem 1.1], any two homology spheres are related to each other by a finite sequence of  $(\pm 1)$ -surgery on knots with some fixed Alexander polynomial. (see [27] for precise.) As an application of our argument, together with Lescop's result [47, Theorem 1.1], we can generalize Ishiwata's result [27, Theorem 1.2] in the following sense.

**Theorem 6.0.18.** *Let  $H$  and  $H'$  be two integral homology spheres,  $k$  an integer, and  $\Lambda(t)$  be Alexander polynomial with  $\frac{1}{2}\Lambda''(1) = k$ . Then the Casson invariants  $\lambda(H)$  and  $\lambda(H')$  coincide modulo  $k$  if and only if  $H_2$  is obtained from  $H_1$  by surgery on a framed boundary link such that each framing is 1 or  $-1$  and the Alexander polynomial of each component is  $\Lambda(t)$  in  $H$ .*

*Proof.* We can obtain a homology sphere  $H''$  with  $\lambda(H'') = \lambda(H')$  from  $H$  by a finite sequence of  $(\pm 1)$ -surgery on knots  $K$  with  $\Delta_K(t) = \Lambda(t)$  since  $\lambda(H) \equiv \lambda(H') \pmod{k}$ . By [47, Theorem 1.1],  $H'$  is obtained from  $H''$  by a finite number of surgery along knots  $K$  with  $\Delta_K(t) = 1$ . Hence it is sufficient to generalize [27, Lemma 2.1] in the following.

**Lemma 6.0.19.** *Let  $H$  and  $H'$  be integral homology spheres. Suppose that  $H'$  is obtained from  $H$  by surgery on a framed knot  $(K, \varepsilon)$  with  $\Delta_K(t) = 1$ . Then for any integer  $k$  and any Alexander polynomial  $\Lambda(t)$  such that  $\frac{1}{2}\Lambda''(1) = k$ , there is a surgery sequence  $H \xrightarrow{(K_1, \varepsilon)} H'' \xrightarrow{(K_2, -\varepsilon)} H'$  such that  $\Delta_{K_1 \subset H}(t) = \Delta_{K_2 \subset H''}(t) = \Lambda(t)$ .*

*Proof.* Put  $f(z) = \Lambda(t)|_{z=-\sqrt{t+1}/\sqrt{t}}$ . Then we have  $f(z) = 1 + \sum_{i=1}^n c_i z^{2i}$  for some  $(c_1, \dots, c_n)$  such that  $c_1 = k$ . Let  $L = C_1 \cup C_2$  be the link in a 3-ball  $B_0$  illustrated in Figure 6.10, where  $m = n$ ,  $d'_i = c'_i = (-1)^{i-1} c_i$  for  $i > 1$  and  $c'_1 - d'_1 = k$ . We perform surgery on  $(C_2, \varepsilon)$  and obtain a framed knot  $(K_1, \varepsilon)$  from  $(C_1, \varepsilon)$ . Let  $(C_2^*, -\varepsilon)$  be the dual framed knot to  $(C_2, \varepsilon)$  and we put  $L' = C_1 \cup C_2^*$ .

Let  $B$  be a 3-ball in  $H$  such that  $B \cap K$  consists of a trivial properly embedded connected arc in  $B$ . We can embed  $L'$  in  $H$  locally so that  $L'$  is contained in  $B$  and  $B \cap K$  is still trivial in  $B - L'$ . Then we can perform a connected sum  $C_1^* = K \# C_1$  on  $K$  and  $C_1$  in  $B$  by the same argument in the proof of [27, Lemma 2.1]. Now we have  $\Delta_{C_1^* \subset H}(t) = \Lambda(t)$  and  $\Delta_{C_2^* \subset \chi(H; (C_1^*, \varepsilon))}(t) = \Lambda(t)$ . It is not hard to see that the homology sphere  $\chi(H; (C_2^*, -\varepsilon))$  is homeomorphic to  $H$  since  $C_2^*$  is a trivial knot in  $H$  and in  $\chi(H; (C_2^*, -\varepsilon))$ ,  $C_1^*$  is viewed as

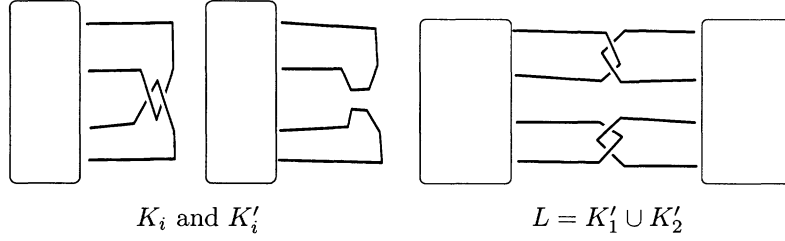

Figure 6.11:

a framed knot equivalent to  $K$  in  $H$ . Thus, we have  $\chi(H; (C_1^*, \varepsilon) \cup (C_2^*, -\varepsilon)) = H'$  and the sequence  $H \xrightarrow{(C_1^*, \varepsilon)} H'' \xrightarrow{(C_2^*, -\varepsilon)} H'$  is a desired one.  $\square$

This completes the proof of Theorem 6.0.18.  $\square$

### 6.0.7 More on Theorem 6.0.9

More generally, one can also construct knots which satisfy the condition in Theorem 6.0.9 from two unknotting number one knots by the help of the following proposition which is proved by an argument similar to the proof of Theorem 6.0.9. (This is not used here and a proof will be given elsewhere.)

**Proposition 6.0.20.** *Let  $K_1$  and  $K_2$  be unknotting number one knots such that each  $K_i$  is obtained from a trivial knot  $K_i'$  by a single 0-linking full twist of two strings. Let  $K_i^*$  be the knot obtained from  $K_i'$  by performing  $\varepsilon_{(i)}$ -surgery along  $K_i'$ . (cf. Figure 6.11) Then  $\nabla_{K_i^*}(z) = \nabla_{K_i}(z) + \varepsilon_{(i)}a_2(K_{(i)})z^2$ , where (1) = 2 and (2) = 1.*

Now for our interest, we ask the following.

**Question 6.0.21.** *Let  $n > 2$  be a natural number. Let  $f_1, \dots, f_i(z) = \sum_{j=2}^{m_i} c_{i,j}z^{2j}, \dots, f_n$  be  $n$  polynomials in  $z^2$ . For any  $a \in \mathbb{Z}$ , do there exist (+1)-framed knots  $\mathcal{K}_1, \dots, \mathcal{K}_i = (K_1, 1), \dots, (K_n, 1)$  in a homology sphere  $H$  such that  $\nabla_{\mathcal{K}_i}(z) = 1 + az^2 + f_i(z)$  and they define the same surgery homology sphere  $\chi(H; \mathcal{K}_i) = H'$ ?*

Proposition 6.0.13 and Proposition 6.0.23 below may expect the following.

**Question 6.0.22.** *Let  $\mathcal{K}_1 = (K_1, 1/n_1)$ ,  $\mathcal{K}_2 = (K_2, 1/n_2)$  be two colored knots in a homology sphere  $H$ . Suppose they define the same surgery homology sphere  $\chi(H; \mathcal{K}_1) = \chi(H; \mathcal{K}_2)$ . Then does it follow that  $n_1a_{2i}(K_1) - n_2a_{2i}(K_2) \equiv 0 \pmod{n_1n_2}$  for any  $i > 0$ ?*

A counterexample to this question is constructed as follows: Let  $K$  be the figure-eight knot, and  $K'$  its (2, 1)-cable. It can be seen that  $\chi(S^3, (K, 1/4)) = \chi(S^3, (K', 1))$  ([55, Proposition 1.1]). However we have  $\nabla_K(z) = 1 - z^2$ ,  $\nabla_{K'}(z) = 1 - 4z^2 - z^4$ .

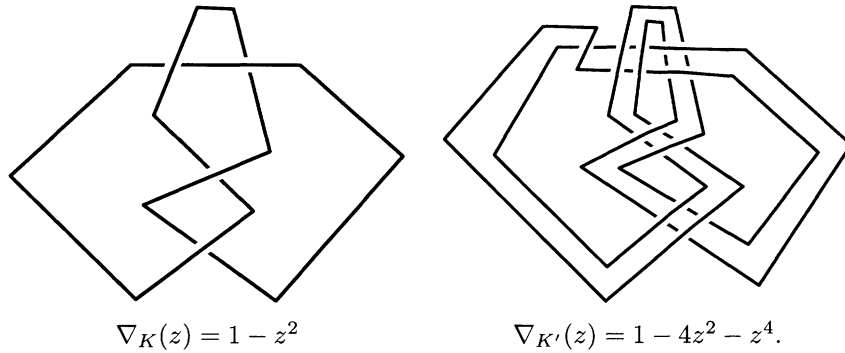

Figure 6.12:

When  $i = 1$ , we have  $n_1 a_2(K_1) - n_2 a_2(K_2) = 0$  by Casson's surgery formula. On the other hand, one can construct two knots  $K_1$  and  $K_2$  from a link illustrated in Figure 6.10 by performing  $(1/n_i)$ -surgery on each component such that  $\chi(S^3; (K_1, 1/n_1)) = \chi(S^3; (K_2, 1/n_2))$  and  $n_1 a_{2i}(K_1) \neq n_2 a_{2i}(K_2)$ , but  $a_{2i}(K_1) | n_2$  and  $a_{2i}(K_2) | n_1$  for  $i > 1$ . More generally, in constructing two knots  $K_1$  and  $K_2$  yielding the homeomorphic homology spheres, one may begin with a two-component Brunnian link  $C_1 \cup C_2$  with linking number 0 and twisting  $n_1$ -times along  $C_1$  ( $n_2$ -times along  $C_2$  resp.),  $K_2$  is obtained from  $C_2$  as the result  $\chi(C_2; (K_1, 1/n_1))$ . ( $K_1$ ,  $C_1$  and  $\chi(C_1; (K_2, 1/n_2))$  resp.) However their Conway polynomials have restricted forms in the sense of Question 6.0.22 by the following proposition.

**Proposition 6.0.23.** *Let  $K$  be a knot in a homology sphere  $H$ . Let  $C$  be a knot in  $H$  disjoint from  $K$  such that  $lk(K, C) = 0$ . Put  $H' = \chi(H; (C, -1/n))$  and  $K' = \chi(K; (C, -1/n))$ . Then it follows that  $\nabla_{K'}(z) - \nabla_K(z) = nz^2 f(z)$  for some polynomial  $f(z)$  in  $z^2$ .*

*Proof.* It is observed that  $K$  bounds a Seifert surface  $S$  disjoint from  $C$  such that for some basis  $\vec{v} = (v_1, \dots, v_k, v_{k+1}, \dots, v_m)$  for  $S$ ,  $lk(v_i, C) = 1$  for  $i = 1, \dots, k$  and  $lk(v_j, C) = 0$  for  $j = k + 1, \dots, m$ . Now  $S$  remains in  $H'$  as a Seifert surface  $S'$  for  $K'$  and we put  $\vec{v}' = (v'_1, \dots, v'_m)$  which is the basis for  $S$  corresponding to  $\vec{v}$ . By Lemma 6.0.10, we have

$$V_{S', \vec{v}'} = V_{S, \vec{v}} + \begin{pmatrix} N & O \\ O & O \end{pmatrix}$$

where  $N$  is the  $k \times k$ -matrix with all elements equal to  $n$ . Thus we can see that

$$\begin{aligned} \Delta_{K'}(t) &= \det \left( (\sqrt{t} V_{S, \vec{v}} - 1/\sqrt{t} V_{S, \vec{v}}^T) + \begin{pmatrix} (\sqrt{t} - 1/\sqrt{t})N & O \\ O & O \end{pmatrix} \right) \\ &= \Delta_K(t) + n(\sqrt{t} - 1/\sqrt{t})F(t). \end{aligned}$$

where  $F(t)$  is a Laurent polynomial in  $t$ . Since  $K'$  is a knot,  $F(t)$  factors  $\sqrt{t} - 1/\sqrt{t}$  and we can write  $F(t) = (\sqrt{t} - 1/\sqrt{t})F_0(t)$ . Thus by the translation  $z = -\sqrt{t} + 1/\sqrt{t}$ , the conclusion follows.  $\square$

Related to Theorem 6.0.9, it is natural to ask the following.

**Question 6.0.24.** *Suppose a homology sphere  $H$  contains a knot  $K$  such that  $\chi(H; (K, 1/n))$  is homeomorphic to  $H$  orientation preservely for some  $n \neq 0$ . Then does it follow that  $\nabla_K(z) = 1$ ?*

In the case when  $H = S^3$ , Gordon-Luecke theorem [14] implies that  $K$  is a trivial knot and thus  $\nabla_K(z) = 1$ .



# Bibliography

- [1] C. Adams and A. Reid, *Quasi-Fuchsian surfaces in hyperbolic knot complements*, J. Austral. Math. Soc. (Ser. A) **55** (1993), 116–131.
- [2] S. Akbulut and J. McCarthy, *Casson's invariant for oriented homology 3-spheres: an exposition*, Princeton University Press, Princeton 1990.
- [3] F. Bonahon, *Bouts des variétés hyperboliques de dimension 3*, Ann. of Math. **124** (1986) 71–154.
- [4] C. Cao and R. Meyerhoff, *The orientable cusped hyperbolic 3-manifolds of minimum volume*,  
<http://fnwww.bc.edu/MT/meyerhoff/CuspedMin14.tex.txt>
- [5] M. Culler, C. Gordon, J. Luecke, and P. Shalen, *Dehn surgery on knots*, Ann. of Math. **125** (1987), 237–300.
- [6] M. Eudave-Muñoz, *Incompressible surfaces in tunnel number one knot complements*, Topology Appl. **98** (1999), 167–189.
- [7] S. Fenley, *Quasi-Fuchsian Seifert surfaces*, Math. Z. **228** (1998), 221–227.
- [8] W. Floyd and U. Oertel, *Incompressible surfaces via branched surfaces*, Topology, **23** (1984), 117–125.
- [9] H. Fujii, *Geometric indices and the Alexander polynomial of a knot*, Proc. Amer. Math. Soc. **124** (1996), 2923–2933.
- [10] D. Gabai, *Foliations and the topology of 3-manifolds*, J. Diff. Geom. **18** (1983), 445–503.
- [11] D. Gabai, *Foliations and the topology of 3-manifolds III*, J. Diff. Geom. **26** (1987), 479–536.
- [12] R. Gitik, M. Mitra, E. Rips and M. Sageev, *Widths of subgroups*, Trans. Amer. Math. Soc. **350** (1998), 321–329.

- [13] C. McA. Gordon, *On primitive sets of loops in the boundary of a handlebody*, *Topology Appl.* **27** (1987) 285–299.
- [14] C. McA. Gordon and J. Luecke, *Knots are determined by their complements*, *J. Amer. Math. Soc.* **22** (1989), 371–415.
- [15] R. F. Gustafson, *A simple genus one knot with incompressible spanning surfaces of arbitrarily high genus*, *Pacific J. Math.* **96** (1981), 81–98.
- [16] W. Haken, *Theorie der Normalflächen*, *Acta. Math.* **105** (1961), 245–375.
- [17] J. Hass, *Acylindrical surfaces in 3-manifolds*, *Michigan Math. J.* **42** (1995), no. 2, 357–365.
- [18] A. Hatcher, *On the boundary slopes of incompressible surfaces*, *Pacific J. Math.* **99** (1982), 373–377.
- [19] A. Hatcher and U. Oertel, *Boundary slopes for Montesinos knots*, *Topology* **28** (1989), 453–480.
- [20] A. Hatcher and W. Thurston, *Incompressible surfaces in 2-bridge knot complements*, *Invent. Math.* **79** (1985), 225–246.
- [21] J. Hempel, *3-manifolds*, *Annals of Math. Studies* **86**, Princeton University Press. Princeton 1976.
- [22] K. Ichihara and M. Ozawa, *Accidental surfaces in knot complements*, *J. Knot Theory and its Ramifications*, **9** (2000), 725–733.
- [23] K. Ichihara and M. Ozawa, *Hyperbolic knot complements without closed embedded totally geodesic surfaces*, *J. Austral. Math. Soc. Ser. A*, **68** (2000), 379–386.
- [24] K. Ichihara and M. Ozawa, *Accidental surfaces and exceptional surgeries*, *Osaka J. Math.* **39** (2002), no. 2, 335–343.
- [25] K. Ichihara, M. Ozawa and Y. Tsutsumi, *A survey on accidental surfaces in knot complements*,  
available at <http://www.musubime.com/knot/accidental.tex>
- [26] H. Inaba and T. Soma, *On spatial graphs isotopic to planar embeddings*, *KNOTS '96* (Tokyo), 1–22, World Sci. Publishing, River Edge, NJ, 1997.
- [27] M. Ishiwata, *A surgery description of an integral homology three-sphere respecting the Casson invariant*, *J. Knot Theory Ramifications* **10** (2001), no. 6, 907–911.
- [28] W. Jaco, *Lectures on Three Manifold Topology*, AMS. Conference board of Math. No. 43, 1980.

- [29] W. Jaco and U. Oertel, *An algorithm to detect if a 3-manifold is a Haken manifold*, Topology **23** (1984) 195–209.
- [30] W. Jaco and P. Shalen, *Seifert fibered spaces in 3-manifolds*, Mem. Amer. Math. Soc. **21**, (1979).
- [31] W. Jaco and J. L. Tolleson, *Algorithms for the complete decomposition of a closed 3-manifolds*, Illinois J. Math. **39** (1995), 358–406.
- [32] W. Jaco, *Adding a 2-handle to a 3-manifold: an application to property R*, Proc. Amer. Math. Soc. **92** no. 2, (1984) 288–292.
- [33] K. Johannson, *Homotopy equivalence of 3-manifolds with boundary*, Lecture notes in Mathematics **761**, Springer-Verlag, 1979
- [34] K. Johannson, *On surfaces and Heegaard surfaces*, Trans. Amer. Math. Soc. **325** (1991), 573–591.
- [35] A. Kawauchi, *Almost identical imitations of  $(3, 1)$ -dimensional manifold pairs*, Osaka J. Math. **26** (1989) 743–758.
- [36] A. Kawauchi, *Mutative hyperbolic homology 3-spheres with the same Floer homology*, Geometriae Dedicata **61** (1996), 205–217.
- [37] S. Kinoshita, *Elementary ideals in knot theory*, Lectures at Kwansei Gakuin University. (Notes by H. Murakami, A. Pizer, and K. Sugishita)
- [38] R. Kirby, *A calculus for framed links in  $S^3$* , Invent. Math. **45** (1978), 36–56.
- [39] T. Kobayashi, *Structures of the Haken manifolds with Heegaard splittings of genus two*, Osaka J. Math. **21** (1984), 437–455.
- [40] T. Kobayashi, *Structures of full Haken manifolds*, Osaka J. Math. **24** (1987), 173–215.
- [41] T. Kobayashi, *A construction of 3-manifolds whose homeomorphism classes of Heegaard splittings have polynomial growth*, Osaka J. Math. **29** (1992), 653–674.
- [42] S. Kojima and Y. Miyamoto, *The smallest hyperbolic 3-manifolds with totally geodesic boundary*, J. Diff. Geom. **34** (1991), 175–192.
- [43] M. Kouno, K. Motegi and T. Shibuya, *Twisting and knot types*, J. Math. Soc. Japan **44** (1992), 199–216.
- [44] H. Kneser, *Geschlossene flächen in dreidimensionalen mannigfaltigkeiten*, Jahresbericht der Deut. Math. **38** (1929), 248–260.

- [45] W. B. R. Lickorish, *A representation of orientable combinatorial 3-manifolds*, Ann. of Math. **76**, 531–538.
- [46] F. Lei, *A general handle addition theorem*, Math. Z. **221**, (1996) 211–216.
- [47] C. Lescop, *On the kernel of the Casson invariant*, Topology, **37** (1998), no. 1, 25–37.
- [48] C. Lescop, *Global surgery formula for the Casson-Walker Invariant*, Annals of Math. Studies **140**, Princeton University Press. Princeton 1996.
- [49] H. C. Lyon, *Incompressible surfaces in knot spaces*, Trans. Amer. Math. Soc, **157** (1971), 53–62.
- [50] H. C. Lyon, *Knots without unknotted incompressible spanning surfaces*, Proc. Amer. Math. Soc. **35** (1972), 617–620.
- [51] H. C. Lyon, *Simple knots without unique minimal surfaces*, Proc. Amer. Math. Soc. **43** (1974), 449–454.
- [52] W. Menasco and A. Reid, *Totally geodesic surfaces in hyperbolic link complements*, in Topology'90, de Gruyter, Berlin, (1992), 215–226.
- [53] J. Milnor, *A unique factorization theorem for 3-manifolds*, Amer. J. Math. **84** (1962), 1–7.
- [54] J. W. Morgan, *On Thurston's uniformization theorem for three-dimensional manifolds*, in The Smith conjecture, 37–125, Pure Appl. Math., 112, Academic Press. 1979.
- [55] K. Motegi, *Homology 3-spheres which are obtained by Dehn surgeries on knots*, Math. Ann. **281** (1988), 483–493.
- [56] R. Myers, *Simple knots in compact orientable 3-manifolds*, Trans. Amer. Math. Soc, **273** (1982), 75–91.
- [57] R. Myers, *Excellent 1-manifolds in compact 3-manifolds*, Topology Appl. **49** (1993), 115–127.
- [58] D. A. Neumann, *3-Manifolds fibering over  $S^1$* , Proc. Amer. Math. Soc. **58** (1976), 353–356.
- [59] U. Oertel, *Incompressible branched surfaces*, Invent. Math. **76** (1984), 385–410.
- [60] M. Ozawa and Y. Tsutsumi, *Totally knotted Seifert surfaces with accidental peripherals*, Proc. Amer. Math. Soc. (to appear).
- [61] M. Ozawa and Y. Tsutsumi, *Minimally knotted spatial graphs are totally knotted*, preprint.

- [62] J. Przytycki, *n-relator 3-manifolds with incompressible boundary*, London Math. Soc. Lecture Note Series, **142** (1987) 273–285.
- [63] D. Rolfsen, *Knots and links*, Publish or Perish, Inc, 1976
- [64] N. Saveliev, *Lectures on the topology of 3-manifolds: An introduction to the Casson invariant*, de Gruyter Textbook, Walter de Gruyter 1999.
- [65] M. Scharlemann and A. Thompson, *Detecting unknotted graphs in 3-space*, J. Diff. Geom. **34**, (1991) 539–560.
- [66] Z. Sela, *Acylindrical accessibility for groups*, Invent. Math. **129** (1997), 527–565.
- [67] S. Suzuki, *Almost unknotted  $\theta_n$ -curves in the 3-sphere*, Kobe J. Math. **1** (1984), 19–22.
- [68] K. Taniyama, *Irreducibility of spatial graphs*, J. Knot Theory and its Ramifications, **11** (2002) 121–124.
- [69] M. Teragaito, *Homology handles with multiple knot-surgery descriptions*, Topology Appl. **56** (1994), 249–257.
- [70] W. P. Thurston, *The geometry and topology of 3-manifolds*, Lecture notes, Princeton University, 1978.
- [71] W. P. Thurston, *A norm for the homology of 3-manifolds*, Mem. Amer. Math. Soc. **59** (1986), no. 339, i–vi and 99–130.
- [72] Y. Tsutsumi, *An algorithm for acylindrical surfaces in 3-manifolds*, Tokyo J. Math. **24** (2001), 395–405.
- [73] Y. Tsutsumi, *Acylindrical surfaces and branched surfaces I*, Michigan Math. J. **50** (2002), 157–171.
- [74] Y. Tsutsumi, *Universal bounds for genus one Seifert surfaces for hyperbolic knots and surgery with non-trivial JSJT-decompositions*, Interdiscip. Info. Sci. **9** (2003) (to appear)
- [75] Y. Tsutsumi, *Excellent non-orientable Seifert surfaces with arbitrarily distinct boundary slopes*, preprint.
- [76] Y. Tsutsumi, *Hyperbolic knots spanning accidental Seifert surfaces of arbitrarily high genus*, preprint.
- [77] Y. Tsutsumi and H. Yamada, *Variances of Alexander-Conway polynomials under Dehn surgery*, preprint.

- [78] Y. Tsutsumi, *Acylindrical surfaces and an infinite sequence of hyperbolic knots yielding the same homology handle*, preprint. (in preparation)
- [79] Y. Tsutsumi, *Acylindrical surfaces and branched surfaces II*, preprint.
- [80] Y. Tsutsumi, *Embedded essential surfaces in 3-manifolds*, Master Thesis, Keio University, 2001 (revised version).
- [81] A. Ushijima, *The canonical decompositions of some family of compact orientable hyperbolic 3-manifolds with totally geodesic boundary*, *Geom. Dedicata* **78** (1999), no. 1, 21–47.
- [82] K. Waker, *An extension of Casson's invariant*, *Annals of Math. Studies* **126**, Princeton University Press. Princeton 1992.
- [83] F. Waldhausen, *On irreducible 3-manifolds which are sufficiently large*, *Ann. of Math.* **87** (1968), 56–88.
- [84] J. Weeks, 'SNAPPEA, the hyperbolic structures computer program', see note (1992). (For a description, see C. Adams, SNAPPEA: The Week's hyperbolic 3-manifold program, *Notices Amer. Math. Soc.* **37** (1990), 273–275)
- [85] Y.-Q. Wu, *On planarity of graphs in 3-manifolds*, *Comment. Math. Helv.* **67** (1992), no. 4, 635–647.
- [86] Y.-Q. Wu, *Minimally knotted embeddings of planar graphs*, *Math. Z.* **214** (1993), no. 4, 653–658.
- [87] Y.-Q. Wu, *Trivial cycles in graphs embedded in 3-manifolds*, *Bull. London Math. Soc.* **28** (1996), 190–196.
- [88] H. Yoshida, *Volumes of orientable 2-cusped hyperbolic 3-manifolds*, *Kobe J. Math.* **18** (2001), 147–161.